

Xerox[®] DocuMate[®] 4830

Scanner User Guide

Mac OS X[®] Users



Design © 2016 Xerox Corporation. All rights reserved. Xerox®, Xerox and Design® and DocuMate® are registered trademarks of Xerox Corporation in the United States and/or other countries and are used under license from Xerox Corporation. Visioneer is a trademark licensee of Xerox®. BR19216

Content © 2016 Visioneer, Inc. All rights reserved. The Visioneer brand name and OneTouch® logo are registered trademarks of Visioneer, Inc.

Reproduction, adaptation, or translation without prior written permission is prohibited, except as allowed under the copyright laws. Copyright protection claimed includes all forms of matters of copyrightable materials and information now allowed by statutory or judicial law or hereinafter granted, including without limitation, material generated from the software programs which are displayed on the screen such as styles, templates, icons, screen displays, looks, etc.

Document Version: 05-0943-000 (July 2016)

Mac®, Mac OS®, and OS X® are trademarks of Apple Inc., registered in the U.S. and other countries.

Adobe®, Adobe® Acrobat®, Adobe® Reader®, and the Adobe® PDF logo are registered trademarks of Adobe Systems Incorporated in the United States and/or other countries.

Post-It® is a registered trademark of 3M in the United States and/or other countries.

TWAIN™ is a trademark of TWAIN Working Group.

Intel® and Pentium® are trademarks of Intel Corporation in the United States and/or other countries.

Universal Serial Bus is a trademark of USB Implementers Forum, Inc. (USB-IF).

Kensington® is a registered trademark of ACCO Brands Corporation.

All other products mentioned herein may be trademarks of their respective companies and are hereby acknowledged.

Changes are periodically made to this document. Changes, technical inaccuracies, and typographic errors will be corrected in subsequent editions. Information is subject to change without notice and does not represent a commitment on the part of Visioneer.

The software described is furnished under a licensing agreement. The software may be used or copied only in accordance with the terms of such an agreement. It is against the law to copy the software on any medium except as specifically allowed in the licensing agreement. No part of this document may be reproduced or transmitted in any form or by any means, electronic or mechanical, including photocopying, recording, or information storage and retrieval systems, or translated to another language, for any purpose other than the licensee's personal use and as specifically allowed in the licensing agreement, without the express written permission of Visioneer.

Restricted Rights Legend

Use, duplication, or disclosure is subject to restrictions as set forth in contract subdivision (c)(1)(ii) of the Rights in Technical Data and Computer Software Clause 52.227-FAR14. Material scanned

by this product may be protected by governmental laws and other regulations, such as copyright laws. The customer is solely responsible for complying with all such laws and regulations.

Table of Contents

Safety	1
Safety Introduction	1
Operational Safety Information.....	1
Electrical Information.....	2
Warning - Electrical Safety Information	2
Electrical Supply	3
Disconnect Device	3
Emergency Power Off	3
Maintenance Information.....	3
Product Safety Certification	4
Environmental Health and Safety Contacts.....	4
Welcome	5
What's in the Box.....	5
System Requirements.....	5
Documentation	6
Xerox® DocuMate® 4830 Scanner	6
Assemble the Scanner	9
Connect the Power Cord.....	10
Installation	11
Connect the USB Cable and Turn on the Power	13
Install the Visioneer Scan Utility.....	14
View the User Guides.....	14
Register Your Scanner.....	14
Loading Documents to Scan	17
Scanning from the Automatic Document Feeder (ADF)	17
Supported Document Types	17
Documents to Avoid Scanning.....	18
Unsupported Document Types.....	18
Preparing Documents for Scanning.....	19
Loading Documents.....	19
Scan from the Flatbed Glass.....	20
Supported Document Types	20
Loading Documents.....	20
Scanning Interfaces	21

Maintenance	23
Safety Precautions	23
Clearing Paper Jams	24
Cleaning the Scanner	24
Cleaning the Automatic Document Feeder	24
Cleaning the Scanner Glass	26
Replacing the ADF Pad and Roller(s)	26
Replacing the ADF Pad Assembly	27
Replacing the Feed Roller	28
Troubleshooting	30
Error Light Troubleshooting Codes	31
Xerox® DocuMate® 4830 Specifications	32
Xerox® DocuMate® 4830 Parts List	35
 Regulatory Information	 37
Basic Regulations	37
United States (FCC Regulations)	37
European Union	37
Turkey (RoHS Regulation)	38
Copy Regulations	38
United States	38
Canada	39
Other Countries	40
 Compliance Information	 41
Product Recycling & Disposal	41
USA & Canada	41
European Union	41
ENERGY STAR for the USA	42

Safety

Safety Introduction

Notices and Safety

Please read the following instructions carefully before operating the machine and refer to them as needed to ensure the continued safe operation of your machine.

Your Xerox® product and supplies have been designed and tested to meet strict safety requirements. These include safety agency evaluation and certification, and compliance with electromagnetic regulations and established environmental standards.



The safety and environment testing and performance of this product have been verified using Xerox® materials only. Unauthorized alterations, which may include the addition of new functions or connection of external devices, may impact the product certification. Please contact your Xerox representative for more information.

Operational Safety Information

Your Xerox® equipment and supplies have been designed and tested to meet strict safety requirements. These include safety agency examination, approval, and compliance with established environmental standards.

To ensure the continued safe operation of your Xerox® equipment, follow these safety guidelines at all times:

Do these:

- Always follow all warnings and instructions that are marked on or supplied with the equipment.
- Always use materials specifically designated for this product, the use of other materials may result in poor performance and create a hazardous situation. Do not use aerosol cleaners, they may be explosive and flammable under certain conditions.
- Always exercise care when moving or relocating equipment.
- Always locate the machine on a solid support surface that has adequate strength to support the weight of the machine.
- Always locate the machine in an area that has adequate ventilation and room for servicing.
- Always unplug this equipment from the electrical outlet before cleaning.

Note: Your Xerox® machine is equipped with an energy saving device to conserve power when the machine is not in use. The machine may be left on continuously.

Do not do these:

- Never use a ground adapter plug to connect the equipment to a power outlet that lacks a ground connection terminal.
- Never attempt any maintenance function that is not specifically described in this documentation.
- Never remove covers or guards that are fastened with screws. There are no operator serviceable areas within these covers.
- Never locate the machine near a radiator or any other heat source.
- Never override or “cheat” any of the electrical or mechanical interlock devices.
- Never place this equipment where people might step on or trip on the power cord.



Caution: This device is not intended for use in the direct field of view at visual display workplaces

To avoid incommoding reflections at visual display workplaces this device must not be placed in the direct field of view.

Electrical Information

Warning - Electrical Safety Information

1. The power receptacle for the machine must meet the requirements stated on the data plate on the rear of the machine. If you are not sure that your electrical supply meets the requirements, please consult your local power company or an electrician for advice.
2. The socket outlet shall be installed near the equipment and shall be easily accessible.
3. Use the power cable that is supplied with your machine. Do not use an extension cord or remove or modify the power cord plug.
4. Plug the power cable directly into a correctly grounded electrical outlet. If you are not sure whether or not an outlet is correctly grounded, consult an electrician.
5. Do not use an adapter to connect any Xerox® equipment to an electrical outlet that lacks a ground connection terminal.
6. Do not place this equipment where people might step or trip on the power cable.
7. Do not place objects on the power cable.
8. Do not override or disable electrical or mechanical interlock devices.
9. Do not push objects into slots or openings on the machine. Electrical shock or fire may result.

Electrical Supply

- This product shall be operated from the type of electrical supply indicated on the product's data plate label. If you are not sure that your electrical supply meets the requirements, please consult your local power company for advice.



- Always connect equipment to a correctly grounded power outlet. If in doubt, have the outlet checked by a qualified electrician.

⚠ WARNING: This equipment must be connected to a protective earth circuit

This equipment is supplied with a plug that has a protective earth pin. This plug will only fit into an earthed electrical outlet. This is a safety feature. If you are unable to insert the plug into the outlet, contact your electrician to replace the outlet.

Disconnect Device

The power cable is the disconnect device for this equipment. It is attached to the back of the machine as a plug-in device. To remove all electrical power from the equipment, disconnect the power cable from the electrical outlet.

Emergency Power Off

If any of the following conditions occur, turn off the machine immediately and disconnect the power cable(s) from the electrical outlet(s).

- The equipment emits unusual odors or makes unusual noises.
- The power cable is damaged or frayed.
- A wall panel circuit breaker, fuse, or other safety device has been tripped.
- Liquid is spilled into the machine.
- The machine is exposed to water.
- Any part of the machine is damaged.

Maintenance Information

1. Any operator product maintenance procedures will be described in the user documentation supplied with the product.
2. Do not carry out any maintenance on this product which is not described in the customer documentation.

3. Do not use aerosol cleaners. The use of cleaners that are not approved may cause poor performance of the equipment, and could cause a dangerous condition.
4. Use supplies and cleaning materials only as directed in this manual.
5. Do not remove covers or guards that are fastened with screws. There are no parts behind these covers that you can maintain or service.
6. Do not perform any maintenance procedures unless you have been trained to do them by an authorized local dealer or unless a procedure is specifically described in the user manuals.

Product Safety Certification

This product is certified by the following Agency using the Safety standards listed:

Standard
UL60950-1 (USA)
CSA 22.2 No. 60950-1 (Canada)
IEC 60950-1

Environmental Health and Safety Contacts

Contact Information

For more information on Environment, Health, and Safety in relation to this Xerox® product and supplies, please contact the following customer help lines:

USA & Canada: 1-800-828-6571
Europe: +44 1707 353 434

Welcome

Your new Xerox® scanner can quickly scan stacks of single-sided or double-sided pages and place their electronic images on your computer.

What's in the Box

Before proceeding, check the contents of the box. If items are missing or damaged, contact the dealer where you purchased the scanner.

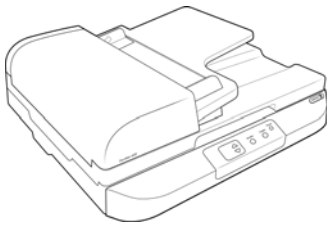

Xerox® DocuMate 4830



Quick Install Guide



Technical Support Card



Warranty Card



USB Cable

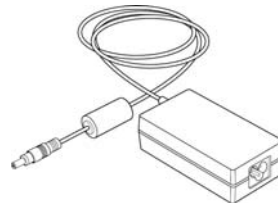

Power Supply

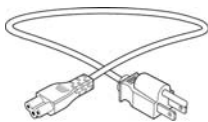

Power Cord



Installation Disc

System Requirements

- Apple® Mac OS X® operating system (10.6 – 10.11)

- 1.83 GHz or faster Intel® Core Processor
- DVD-ROM drive capable of reading Dual Layer DVDs
- An available Universal Serial Bus (USB) port
- Minimum of 2 gigabyte (GB) of internal memory (RAM)
- 350 MB minimum of free hard disk space

Documentation

The following printed documentation is provided in the box:

- **Installation guide**—abbreviated scanner setup and installation instructions.
- **Technical support card**—contact information for technical support and customer service, and a brief overview of our standard product warranty.
- **Warranty card**—the warranty card is provided for users in Russia and should be filled in as described on the card. For all other users, please dispose of this card in paper recycling.

The following soft-copy documentation is available on the installation disc:

- **Scanner user guide**—instructions for scanner setup, installation, operation, maintenance, safety, and warranty. The instructions in this guide cover how to properly use the scanner and perform maintenance. Please refer to your scanning application's user guide or help file for instructions on how to access the scanner's interface, scan and save files.
- **TWAIN scanning guide**—instructions for scanning using the TWAIN interface. This guide describes the options available in the TWAIN interface. Please refer to your scanning application's user guide or help file for instructions on how to access the scanner's interface, scan and save files.

Xerox® DocuMate® 4830 Scanner

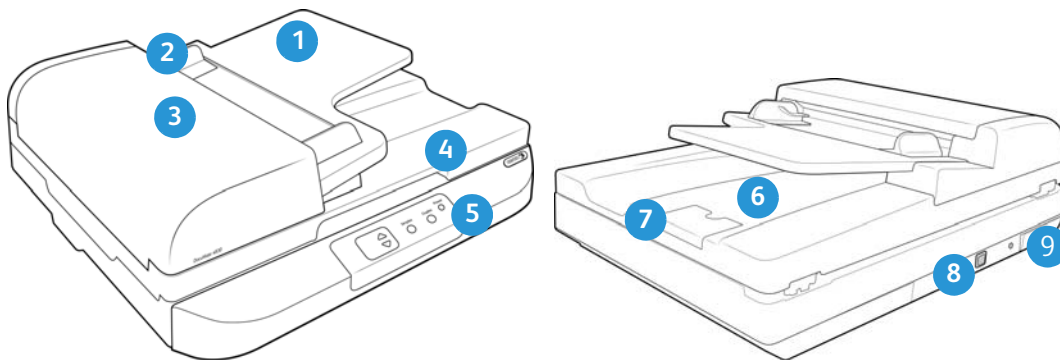

1. **Input Tray**—Holds the documents in the Automatic Document Feeder for scanning.
2. **Paper Guides**—Guides adjust to support various document widths.
3. **ADF Cover**—Pull to open the Automatic Document Feeder.

4. **Scanner Lid**—Lift lid to place an item on the flatbed glass for scanning.
5. **Status light / Power Button**—Turns the scanner's power off and shows the scanner's status.
6. **Output Tray**—Holds documents after being scanned through the Automatic Document Feeder.
7. **Paper Stop**—Holds documents in the output tray.
8. **Universal Serial Bus (USB) port**—Connects the scanner to the computer.
9. **Power jack**—Connects the power cord to the scanner.

Assemble the Scanner

1. Remove all shipping tape from the top and bottom of the scanner.
2. Peel off the protective plastic film from the control panel.

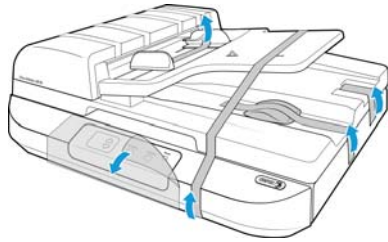

3. Open the automatic document feeder cover and remove any tape or protective foam from inside the feeder. Close the feeder cover when you are finished.

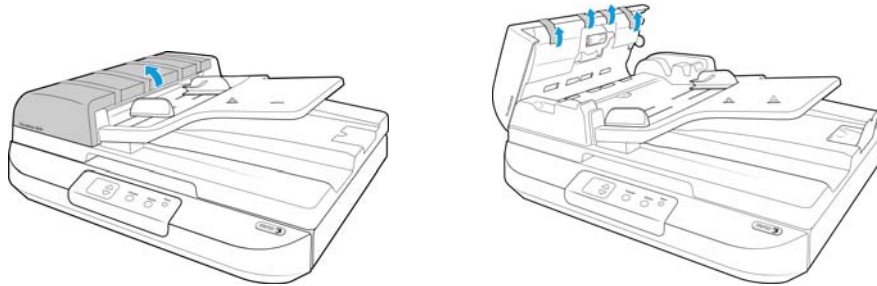

4. Lift the scanner lid.

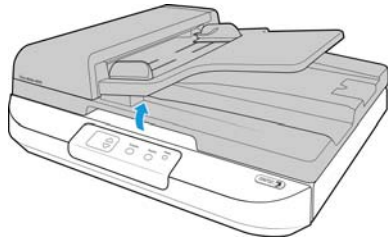

5. Remove any tape and protective foam from around or on the flatbed glass.



- Slide the locking tab to the unlocked position.



- Close the scanner lid when you are finished.

Connect the Power Cord

Note: Only use the power supply (DA-48M24 made by APD) included with your scanner. Connecting any other type of power supply may damage your scanner, and will void its warranty.

- Plug the power supply into the power port on the scanner.
- Plug the power cord into the power supply and into a wall outlet.

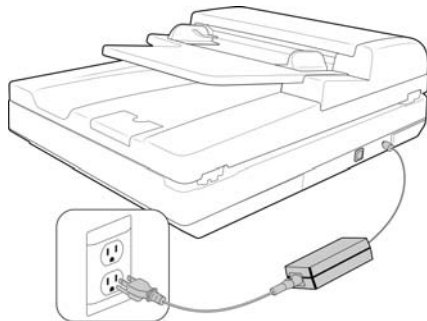

Installation

1. Insert the installation disc into your computer's DVD-ROM drive.



2. Double-click the disc icon that appears on the desktop.



3. Double-click the **Xerox Scanner** file to start the driver installer.



4. Click **Continue**.

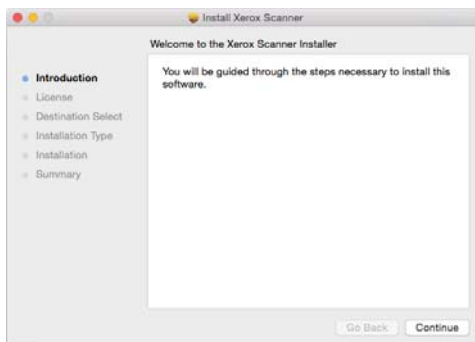

5. On the Xerox License Agreement window, read the license agreement. Click **Continue**.

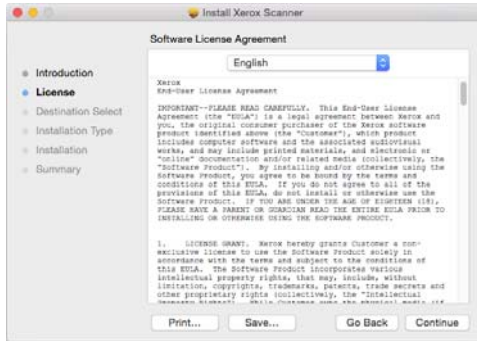

6. If you accept the terms, select **Agree** and continue with the installation.

If you choose not to accept the license agreement, close the installation window. The scanner driver will not be installed.

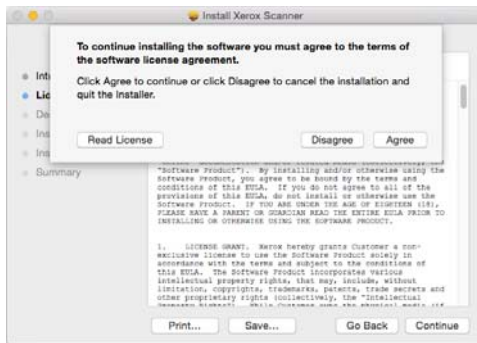

7. Depending on your system configuration, you may be prompted to choose a location for the installation. We recommend that you select the main disc drive and click **Install**.

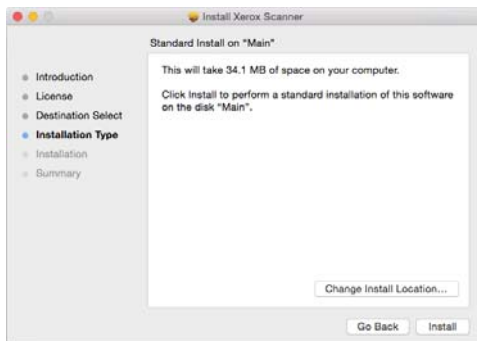

8. If you are prompted for a password, input the name and password for a user that has permission to install software on your computer.



9. Click **Close** on the installation complete window.

You can now connect the scanner to your computer.

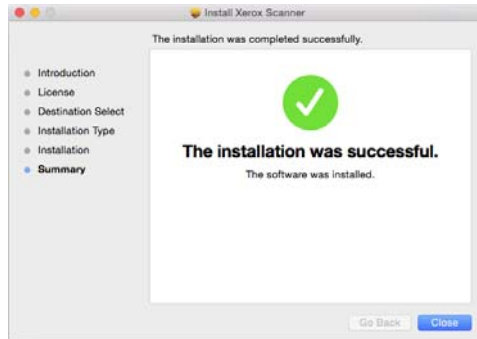

Technical Note: the Installation Complete screen may be blank when installing on OS X (10.9). Please close the empty screen and proceed with connecting the scanner to the computer.

Connect the USB Cable and Turn on the Power

1. Remove any tape from the USB cable.
2. Plug the USB cable into the USB port on the scanner then into a USB port on the computer. Check your computer's manual for USB port locations.

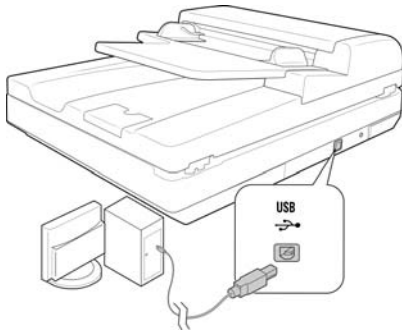

If the plug does not attach easily, make sure that you are plugging it in correctly. Do not force the plug into either connection.

3. Turn on the scanner power.

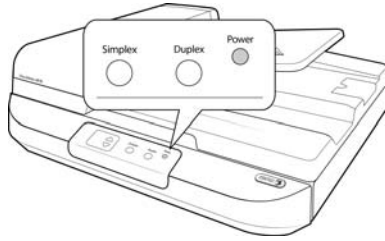

The status light comes on and flashes indicating that the scanner is receiving power.

Your computer recognizes that a scanner has been plugged into the USB port and automatically loads the appropriate software to run the scanner.

Install the Visioneer Scan Utility

From the Finder window for the installation disc, double-click on the installer package for the **Visioneer Scan Utility**. Follow the instructions on the screen to install the application.



Software	About the Software
Visioneer Scan Utility	This utility uses the scanner's TWAIN interface for scanning. You can select a destination folder on your computer and save the image as any one of several popular image file formats (BMP, JPG, GIF, TIF, Multi-Page TIF, PDF, Multi-Page PDF).

View the User Guides

From the **Finder** window for the installation disc, double-click on the **Documentation** folder.

- **Scanner user guide**—instructions for scanner setup, installation, operation, maintenance, safety, and warranty.
- **TWAIN scanning guide**—instructions for accessing and scanning using the TWAIN interface.

Register Your Scanner

Registering your scanner is important as it provides you with access to our free telephone support service. Registration also gives you free access to software updates for your scanner.

You will need an active internet connection to register your scanner. If you do not have internet access you can contact our customer service department to register the scanner. Please refer to the Technical Support Card, that you received with the scanner, for our customer service contact information.

1. Open **Safari** or any other Internet browser you have installed on your computer.
2. In the web address field type www.xeroxscanners.com.
3. Press Enter on your computer's keyboard or click the option on screen to go to the web address.
4. When the Xerox® scanners web page loads click on **Register Your Product**.
5. Fill in the registration form, all required fields have an asterisk (*).
A valid email address is required for registration.
6. You will be asked to enter the serial number for the scanner, it is located on the back or underside of the scanner.
7. After filling in the form, click on **Submit Your Registration** to complete the registration.

Loading Documents to Scan

Always remove any staples or paper clips from documents before inserting them into the scanner. Staples and paper clips can jam the feed mechanism and scratch the internal components. Also remove any labels, stickers, or Post-It™ notes that may come off during the scanning process and get stuck in the scanner. Misuse as described here will void your scanner's warranty.



Scanning from the Automatic Document Feeder (ADF)

Supported Document Types

You can scan the following types of documents and cards with this scanner.

- Maximum amount of paper in the input tray
 - Approximately 75 pages of 20 lb (75–80 g/m²) new printer paper
- Document size
 - Minimum size (width x length) – 4.0 x 4.13 inches (102 x 105 mm)
 - Maximum size (width x length) – 11.7 x 17 inches (297 x 432 mm)
 - Maximum length with long document enabled – 118 inches (2997 mm)
 - We recommend scanning one page at a time when the documents you are scanning are longer than 17 inches (432 mm).
- Mixed document stacks
 - Scanner minimum to maximum without long document enabled
 - Arrange the documents so that all items are centered in the stack. The document sensor, paper separation, and feed rollers are located in the middle of the paper path. If smaller items are offset from the center they will not be detected. This will cause feeding issues and paper jams.
- Paper thickness between 14–28 lb paper (53–105 g/m²)

Documents to Avoid Scanning

The documents in this list can be scanned, but please note that scanning documents of this type will reduce the life of the scanner. Maintenance will be required more often and replaceable parts will wear faster. These types of documents will jam more frequently and damage to the original documents may occur. If you do choose to scan these document types, do not scan large batches. This type of use is not covered under the scanner warranty and alters replacement parts life expectancy.

We recommend you limit the amount or completely avoid scanning documents that are in this list.

- Curled, wrinkled or folded documents may cause paper jams or multiple pages being fed through the scanner at one time.
- Perforated or punched paper that could tear when the separation roller engages.
- Coated paper or photographs where the coating can flake off during scanning and leave residue in the scanner.
- Extremely smooth, shiny, or highly textured paper may cause the paper feed rollers to slip across the page and cause the scanner to report a paper jam.
- Carbonless copy paper may tear while being fed through the scanner and the pressure of the rollers may leave streaks on the page. The chemical coating on this paper will rub off on the rollers during the scan process, increasing the frequency of miss-feeds and paper jams.
- Partially transparent paper such as tracing paper as any images from the opposite side of the page or black background will appear in the scanned images.

Unsupported Document Types

Do not scan the following types of documents as they may cause damage to the scanner.

- Items outside of the specified supported sizes, thickness, and weight defined in this document.
- Non-rectangular or irregularly shaped paper will cause the scanner to detect and report document skew errors or paper jams.
- Carbon paper that will leave residue in the scanner and on the rollers that will transfer to the next set of documents scanned.
- Documents with hard items attached such as paper clips, binder clips, and staples.
- Documents with wet ink or white-out.
- Thermal or photosensitive paper.
- Overhead projector sheets, plastic film, camera film, and any other type of transparent or partially transparent plastic item.
- Documents that have been glued together.
- Cloth or metallic sheets.

Preparing Documents for Scanning

- Fan the documents to make sure all pages in the stack are separated.



- Bend and then flatten the document stack to make sure the horizontal edges are aligned to help prevent paper from skewing while being pulled through the scanner.

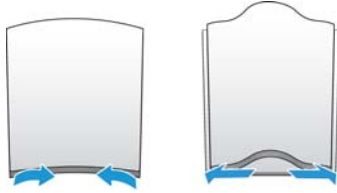

- Pinch the ends to align the leading edges slantwise to help prevent multiple pages from being fed through at a single time.



Loading Documents

1. Unfold the paper guide extension and adjust the paper guides for the size of paper.

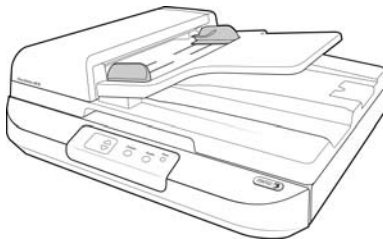

2. Load the documents *face up* with their tops into the Automatic Document Feeder.

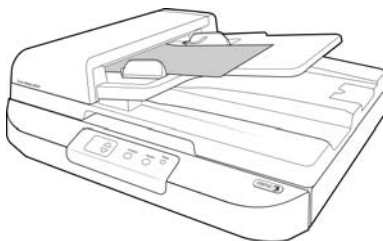

Scan from the Flatbed Glass

Supported Document Types

You can scan the following types of documents with this scanner.

- Document size
 - Minimum size (width x length) – 0.5 x 0.5 inches (13 x 13 mm)
 - Maximum size (width x length) – 11.7 x 16.54 inches (297 x 420 mm)

Loading Documents

Use the Flatbed glass to scan documents on light weight paper, such as credit card receipts, or items that cannot be scanned with the Automatic Document Feeder, such as pages in a book or plastic cards.

Note: You must remove any pages from the Automatic Document Feeder before scanning from the Flatbed glass. If pages are in the Automatic Document Feeder, they will be scanned instead of the page on the Flatbed glass.

1. Remove any pages from the Automatic Document Feeder.
2. Open the scanner lid and place the page on the scanner glass, *face down*.



3. Close the lid.

Scanning Interfaces

Every scanning application will access the scanner using a different method. Please refer to the application's user guide for instructions on using the application and accessing the scanner.

- **TWAIN Interface**—TWAIN is a widely recognized standard that computers use to receive images from scanners and digital cameras. The TWAIN scanning interface can be accessed from any TWAIN scanning application you have installed on the computer.

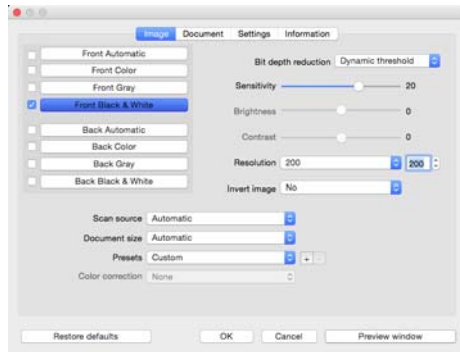

- **ICA Interface**—the ICA driver has been developed to enable image transfer from devices using standard Mac applications, such as Image Capture, without the need to install additional scanning software.



Maintenance

This section contains information about maintenance, troubleshooting, uninstalling, scanner specifications, and spare parts.

Safety Precautions

When servicing the scanner you should take the following precautions to ensure your safety and prevent damage to the scanner.

Do These

- Wear protective gloves when cleaning the scanner with Isopropyl rubbing alcohol. Rubbing alcohol may irritate sensitive skin.
- Only perform scanner maintenance as described in this chapter.
- Keep the scanner and cleaning supplies away from any open flame or heat source as any form of alcohol is flammable.
- Always read the instructions in each section carefully, the instructions are specific to the part you are installing or servicing.
- Move the scanner to an area that has adequate room for opening the scanner.
- If your scanner has a power cord and/or power switch, always turn off the scanner and unplug the power cord before performing maintenance, unless the maintenance instructions below specifically state to leave the scanner plugged in and powered on.
- Always unplug the USB cable from the scanner before performing maintenance, unless the maintenance instructions below specifically state to leave the scanner plugged in.
- Wear an anti-static strap to prevent electrostatic discharge when touching metal components.
- Keep all cleaning supplies, scanner parts and accessories out of the reach of children.

Do Not Do These

- Never attempt installation of any part not described in this manual.
- Never service the scanner near a radiator or any other heat source.
- Never use aerosol sprays or compressed air, or attempt to lubricate parts with an oil or silicon spray.
- Never service the scanner in an area where there are open liquid containers.
- Never pour or spill liquid on the scanner or any of its components.

Clearing Paper Jams

If your scanner stops scanning due to a paper jam in the Automatic Document Feeder, a warning opens after a few moments.

1. Open the Automatic Document Feeder cover.

Do not attempt to remove a jammed page with the scanner closed.

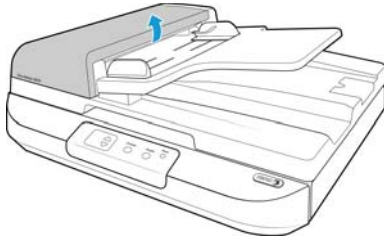

- If the page is jammed at the start of the paper path carefully pull it out of the scanner.
- If the page is jammed farther in the ADF, use the manual feed wheel to feed the jammed page through the ADF. And then pull out the jammed page from under the paper input tray.

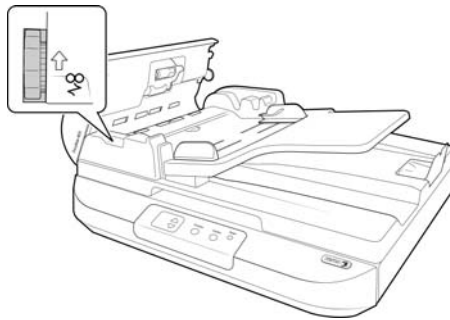

2. Remove the jammed paper and close the cover.

To reduce the number of paper jams, smooth and straighten the paper before scanning, adjust the guides to the paper size, and insert the paper evenly into the ADF

Cleaning the Scanner

Cleaning the Automatic Document Feeder

Cleaning the inside of the scanner helps to keep your scanner operating at optimum performance. You should clean the inside of the scanner at least once a week or after 1,000 pages have been scanned. If you are getting frequent paper jams, multiple pages feeding at the same time, or you're seeing lines in the scanned image, it is time to clean the scanner.

Note: Be careful when cleaning the rollers. All of the rollers, except the free rollers, are designed to rotate in one direction only. Do not force the roller to rotate in the opposite direction. Forcing the roller to rotate will damage it, and cause the scanner to feed pages incorrectly.

1. Wet a soft cloth with some Isopropyl rubbing alcohol (70%).
2. Open the Automatic Document Feeder cover.

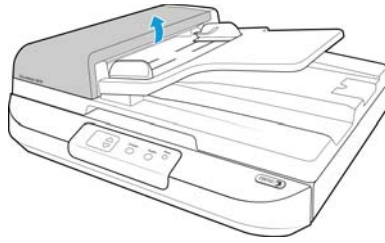

3. Wipe clean the rollers in the scanner. Rotate the rollers to clean the entire surface.
The following illustration shows where the rollers are located in the scanner.

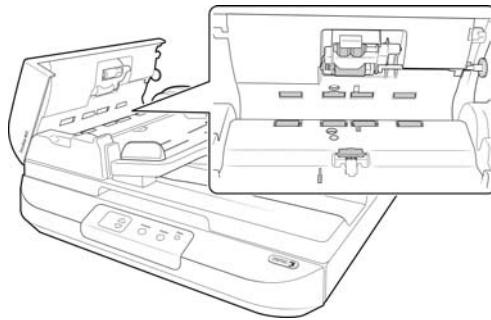

4. Close the ADF door.

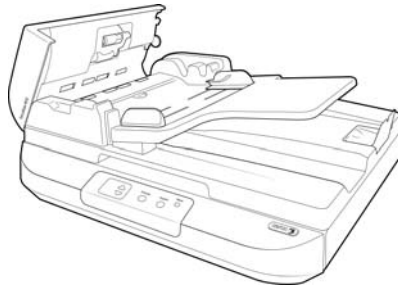

5. Lift the scanner lid.

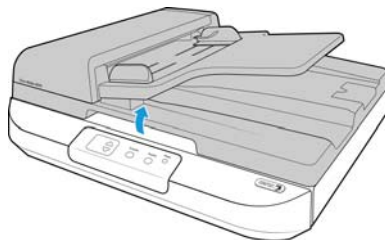

6. Wipe clean the glass strip on the underside of the duplex lamp module. Wipe clean the glass strip in the body of the scanner.



7. Close the scanner when you're finished.

Cleaning the Scanner Glass

Scanning items that have excessive amounts of dirt or dust may dirty the glass. To ensure the best quality scanned item, wipe the scanner glass with a soft, dry, clean cloth to rid the glass of dust or other debris.

If any residue remains after wiping the glass with a dry cloth, try adding a few drops of Isopropyl alcohol (rubbing alcohol) to the cloth and wipe off the residue.



Replacing the ADF Pad and Roller(s)

The ADF pad and/or rollers will wear out and are designed to be user replaceable parts. Each section below indicates the expected scan life of the replaceable part.

Replacing the ADF Pad Assembly

Problems with documents feeding into the ADF is an indication that the pad is wearing thin. The usage life of the ADF pad varies by what type of documents are generally scanned. Scanning large batches of heavily textured paper and embossed plastic cards will cause the ADF pad to wear faster. Large continuous batch scanning will also cause the ADF pad to wear faster. The ADF pad can be used to scan up to 50,000 pages.

You received a replacement pad in the original scanner box, you can also order a new one. Replacement parts can be purchased from the Parts & Accessories page for your scanner at www.xeroxscanners.com.



Discard the parts as you remove them from the scanner, the parts cannot be reused and are a choking hazard.

1. Open the ADF cover. The ADF pad is located on the top of the duplex lamp module.

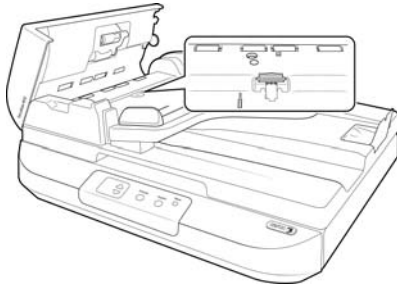

2. Squeeze the plastic clamp that holds the pad assembly in place.

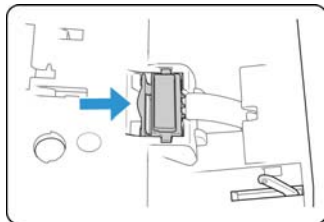

3. Lift the pad up and out of the scanner.
4. Remove the tension spring that is located under the ADF pad.

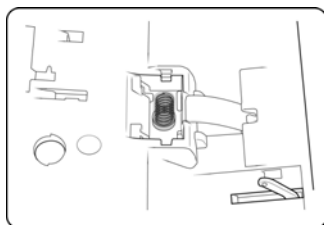

- Place the new tension spring in the scanner.

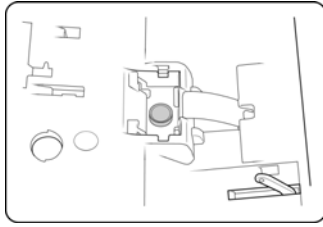

- Place the new ADF pad in the scanner on top of the tension spring.

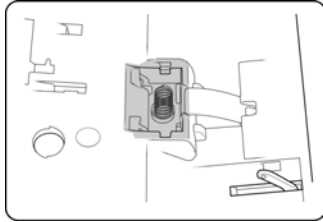

- Press down on the ADF pad until you hear a "click" when it locks in place.
- Close the scanner when you're finished.

Replacing the Feed Roller

The roller will wear out and is designed to be a user-replaceable part. A worn roller can cause documents to feed in skewed at an angle, or multiple pages to feed at the same time. Before replacing the roller you should clean it as excessive dust on the roller will make it appear worn and smooth. You cannot properly diagnose a worn roller until you have cleaned it. You should generally replace the roller every 160,000 to 200,000 scans.

Replacement parts can be purchased from the Parts & Accessories page for your scanner at www.xeroxscanners.com.

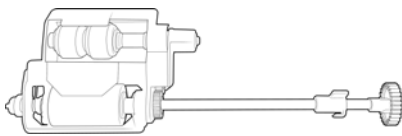

- Open the Automatic Document Feeder cover.

The roller assembly fits in a channel in the ADF cover.

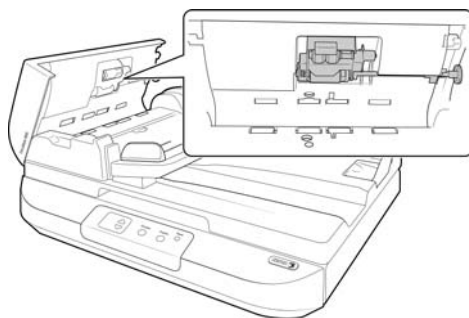

- The roller is held in place with a lock tab that rotates to lock and unlock it. To unlock the tab, rotate it upward until the small lock flange is completely free.

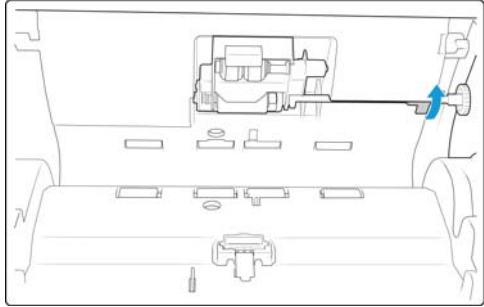

- Remove the roller from the scanner and discard it, it cannot be repaired.

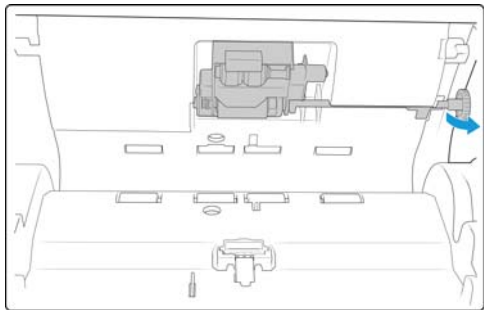

- Before installing the new roller, clean any dust that may have gotten on it during shipping.
- Insert the left end of the new roller assembly into the hole in the roller channel. Angle the roller module up and into the roller channel. Align the tab on the lock flange with the slot in the scanner.

Hold the feed roller module fully in the scanner door while you lock it in place.

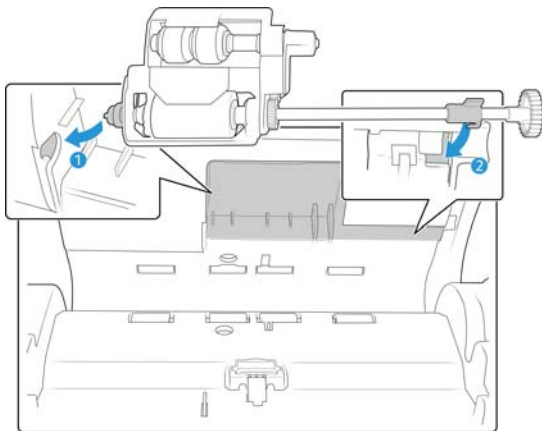

- Use the lever to rotate the locking tab into the slot in the scanner. Push on the lever until it clicks in place and locks the roller in the scanner.

The lock will “click” into place when it is secure. However, if it does not rotate easily into the housing, make sure the flange is properly seated in its latch.

- Close the scanner when you’re finished.

Troubleshooting

Problem: The scanner won't scan.

Check for one of these possible causes:

- **Are the cables loose or not plugged in securely?** Inspect the cable connections. Make sure the cables are plugged in securely.
- **Is the scanner's status light on?** Turn on the scanner's power. If the status light doesn't come on, plug the power supply into another electrical outlet. If you are using a UPS battery back-up or power strip, try plugging the scanner directly to a wall outlet.
- **Did you restart the computer and scanner?** If the scanner gets a paper jam, or loses connection because of an error, try restarting your computer and power cycling the scanner.
- **Did you plug the scanner into a USB hub?** If you're using a USB hub to connect the scanner try plugging the scanner's USB cable directly to the back of the computer. It is not recommended that you use the scanner with a USB hub, if you are using a hub, the hub must have its own power supply.
- **Is the USB cable 6' or less?** If you are using a USB cable that is longer than 6' you may lose connection to the scanner. The recommended USB cable length is 6' or less, the USB cable provided with your scanner is within this range.
- **Did you select another image source in the scanning software?** If you use multiple imaging devices with your computer, such as a camera, all-in-one printer, or another scanner, you may have selected another source for images. Make sure Xerox® DocuMate® 4830 is selected as the scanner.

Problem: My computer keeps giving me out of hard drive space error messages.

The minimum requirement of 500MB free hard drive space is for the installation of the software and basic, low resolution, scanning. High resolution scans result in files that can be over 1 gigabyte in size. Free up some space on your hard drive for the software to be able to save the scanned images.

Problem: My computer keeps giving me out of memory error messages.

An "Out of memory" message may appear when scanning long pages at higher resolutions. This error is most often seen on older versions of Mac OS X, due to the large file size created when scanning long pages in color or grayscale at 300 dpi or higher. If you see an out of memory error message, please try adjusting the page length and/or scan resolution.

Problem: Images are corrupted when scanning and saving as a GIF file format.

This is a known issue when using older versions of OS X, at this time the issue has been seen on 10.6 and 10.7 but you may see this problem on other versions of OS X as well. Please use a different file format when scanning if you are seeing corrupted image.

Problem: The paper jams the ADF.

To reduce the number of paper jams, smooth and straighten the paper before scanning, and adjust the guides to the paper size. If paper jams are occurring more frequently, try cleaning the roller with a soft cloth dampened with Isopropyl rubbing alcohol. Excessive dust on the roller can make it appear worn and will cause issues feeding paper. See “Cleaning the Scanner” on page 24 for cleaning instructions.

Problem: If the USB cable is disconnected during a scan, the scanner does not reconnect when the USB cable is plugged back in.

Unplug the power cable from the scanner, and then plug it back in. If the scanner does not reconnect:

1. Unplug the power cable from the scanner.
2. Restart your computer.
3. After the restart is complete, plug the power cable back in.

Problem: The scans from the input tray are always crooked.

Make sure to align the paper guides to the edges of the paper. If you are scanning small items that are smaller than the paper guides' minimum adjustment, scan these items from the flatbed instead.

Problem: The scanner reports a Double Feed error when there is only one page in the scanner.

Try cleaning the double feed detection sensor. Dust on the sensor may prevent the sensor from working properly.

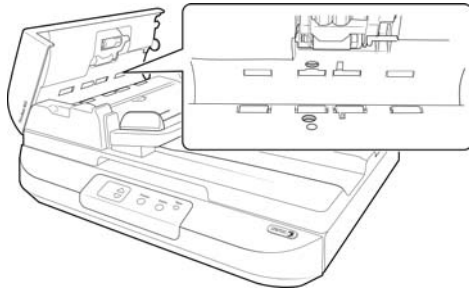

Error Light Troubleshooting Codes

Normal Operation

- **Steady blue:** indicates the scanner is ready to scan.
- **Slow flashing blue:** indicates the scanner is in low power mode.
- **Rapid flashing blue:** indicates the scanner is waking up from low power mode.
- **Steady red:** the scanner is busy or it is not connected to the computer.
- **Flashing red:** the scanner is reporting an error.

Error Codes

The status light indicates the current state of the scanner. If your scanner experiences hardware problems, the status light turns red and will blink a specific number of times, the status light will blink red, and the LED flashes an “E” then the error code number.

Descriptions of the most common patterns are listed below. In all cases, you should turn off the scanner and check the scanner setup. Make sure the USB cable is plugged into the scanner and computer. Make sure the power cord is plugged into the scanner and into a wall outlet. Contact Xerox Technical Support if you experience a different blinking pattern.

Error Code	Problem Description	Solution
0	Scanner is not connected to the computer (The LED does not flash “E” and the status light remains blue.)	A cable may be loose. Check that the scanner’s cables are correctly attached to the computer. If the scanner still does not connect, re-boot the computer.
4	Paper jam	Open the ADF cover and remove the jammed page. See “Clearing Paper Jams” on page 24.
5	Multiple paper feed	Multiple pages have fed through the scanner at one time. Open the ADF door and remove the pages from the scanner. Make sure the pages are not stuck or taped together before loading them in the ADF. If the problem persists, clean the double feed detection sensor as described on the previous section.
6	The scanner’s cover is open	The ADF door is not closed all the way. Open the scanner then close it again. Push down on the lid until it locks into place.
1, 2, 7 or 8	The lamp in the scanner body or lid has malfunctioned	This usually occurs if the power was disconnected during a scan. Turn the scanner off, then back on again. If the problem persists, turn off the scanner, re-start the computer, then turn the scanner on. If the problem continues, and your scanner’s power is plugged into a surge protector or UPS battery backup, try plugging the scanner power directly into a wall outlet.
All Other Codes	An internal part in the scanner may have malfunctioned	Turn off the power to your scanner, then turn it back on. If the problem persists, re-boot your computer. If the problem still persists, contact Xerox Technical Support.

Xerox® DocuMate® 4830 Specifications

Scanner Specifications	
Document Requirements (ADF)	
Minimum Item Size	4 x 4.13 inches (102 x 105 mm)
Maximum Item Size	11.7 x 118 inches (297 x 2997 mm) Note: The maximum page length is 38 inches (965 mm) when scanning in Black and White at 600 dpi.
Capacity	75 pages of 20lb printer paper (75–80 g/m ²)

Scanner Specifications	
Paper Thickness	14–28 lbs. (53–105 g/m ²)
Document Requirements (Flatbed)	
Minimum Item Size	0.5 x 0.5 inches (13 x 13 mm)
Maximum Item Size	11.7 x 16.54 inches (297 x 420 mm)
Paper Thickness	1.0 inch (25 mm)
General Specifications	
Scanning Speed (ADF)	<p>Xerox® DocuMate® 4830 (P/N 85-0302-000 and higher) U.S. Letter landscape or A4 landscape –30 pages per minute / 60 images per minute @ 200 and 300 dpi</p> <p>Xerox® DocuMate® 4830 (P/N 85-0312-000 and higher) U.S. Letter landscape or A4 landscape (Color) –30 pages per minute / 60 images per minute @ 200 and 300 dpi U.S. Letter landscape or A4 landscape (Black & White and Grayscale) –50 pages per minute / 100 images per minute @ 200 and 300 dpi</p> <p>Please see “Checking Your Scanner Version” on page 34</p>
Scanning Speed (Flatbed)	U.S. Letter landscape or A4 landscape (Color) –4.5 seconds per page @ 200 and 300 dpi U.S. Letter landscape or A4 landscape (Black & White and Grayscale) –4 seconds per page @ 200 and 300 dpi
Optical Resolution	600 dpi
Output Bit Depth	24-bit color, 8-bit grayscale, 1-bit bitonal (black & white)
Scan Method	A3 Duplex Automatic Document Feeder (ADF) A3 Simplex Single-Pass Flatbed
Image Sensor	Contact Image Sensor
Light Source	RGB LED lamp
Interface	Hi-Speed USB 2.0
Certifications	UL, C-UL, FCC CLASS A, CE, WEEE, RoHS, ENERGY STAR
Operating Temperature	50° ~ 95° F (10° ~ 35° C without condensation)
Relative Humidity	15% ~ 85% (@35° C without condensation)
Scanner Dimensions	
Width	22.9 inches (581 mm)
Depth	19.6 inches (499 mm)
Height	7.6 inches (194 mm)
Weight	26.4 pounds (12 kg)
Power Information	
Power Supply	APD DA-48M24 DC Jack, 3P, 100–240Vac, 24Vdc, 2A, 48W, Class 1, ENERGY STAR, RoHS



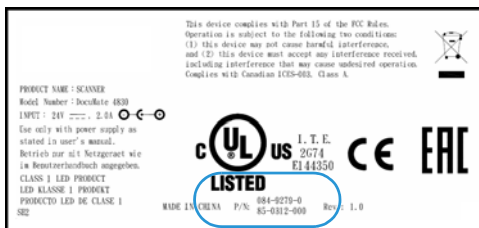

Scanner Specifications	
Scanner Rating	<p>Xerox® DocuMate® 4830 (P/N 85-0302-000 and higher) 24Vdc, 2.0A</p> <p>Xerox® DocuMate® 4830 (P/N 85-0312-000 and higher) 24Vdc, 1.25A</p>
Power consumption	<p>Xerox® DocuMate® 4830 (P/N 85-0302-000 and higher) ≤ 30 Watts (during operation) ≤ 12 Watts (on standby) ≤ 5 Watts (power save after 15 minutes without scanning) ≤ 0.3 Watt (power off)</p> <p>Xerox® DocuMate® 4830 (P/N 85-0312-000 and higher) ≤ 40 Watts (during operation) ≤ 12 Watts (on standby) ≤ 2.9 Watts (power save after 15 minutes without scanning) ≤ 0.5 Watt (power off)</p>
Cable Information	
AC Power Cord	<p>US(UL/CSA)—3P, 10A/125V, L=1800mm, 3C*18AWG, BLACK, PH8B2EDJFOA-05B, RoHS</p> <p>UK(BSI/PSB)—3P, 3A/250V, L=1800mm, 3C*0.75mm², BLACK, PG8B9X3JGOA-05B, RoHS</p> <p>EUR(CEE)—2P+G, 16A/250V, L=1800mm, 3C*0.75mm², BLACK, PG8B9CIJGOA-05B, RoHS</p>
USB cable	1850 mm, 28AWG, with core, RoHS compliant
Software Information	
Supported Operating Systems	Apple® Mac OS X®
Scanner Drivers	TWAIN, ICA
Bundled Software	Visioneer® Scan Utility

Checking Your Scanner Version

The scanner’s part number is located on the data plate, starting with an 85 in the format P/N: 85-####-#00; the image below is shown for example only:

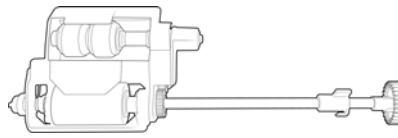

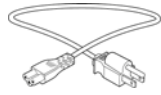
Xerox® DocuMate® 4830 Parts List

Part Name	Part Number	
Feed Roller	57-0151-000	
ADF Pad Tension Spring	57-0150-000	
USB Cable	35-0118-000	
AC Power Cord	35-0103-000 (US) 35-0104-000 (EUR) 35-0105-000 (UK)	
Power Supply	37-0095-000	

Regulatory Information

Basic Regulations

United States (FCC Regulations)

This equipment has been tested and found to comply with the limits for a Class A digital device, pursuant to Part 15 of the FCC Rules. These limits are designed to provide reasonable protection against harmful interference when the equipment is operated in a commercial environment. This equipment generates, uses, and can radiate radio frequency energy and, if not installed and used in accordance with the instruction manual, may cause harmful interference to radio communications.

Operation of this equipment in a residential area is likely to cause harmful interference in which case the user will be required to correct the interference at his own expense.



WARNING:

In order to allow this equipment to operate in close proximity to Industrial, Scientific and Medical (ISM) equipment, the external radiation from ISM equipment may have to be limited or special mitigation measures taken.

Changes and modifications to this equipment not specifically approved by Xerox may void the user's authority to operate this equipment.

Shielded cables must be used with this equipment to maintain compliance with FCC regulations.

European Union

The CE mark applied to this product, symbolizes our declaration of conformity with the following applicable European Union Directives, as of the dates indicated:



December 12, 2006:	Council Directive 2006/95/EC as amended. Approximation of the laws of the member states related to low voltage equipment.
December 31, 2004:	Council Directive 2004/108/EC as amended. Approximation of the laws of the member states related to electromagnetic compatibility.

This machine is certified as Class 1 LED product. This means that this machine does not produce hazardous laser radiation.

A full declaration of conformity, defining the relevant directives and referenced standards, can be obtained from your Xerox Limited representative or by contacting:

Environment, Health and Safety
 The Document Company Xerox
 Bessemer Road
 Welwyn Garden City
 Herts
 AL7 1HE
 England, Telephone +44 (0) 1707 353434

Turkey (RoHS Regulation)

In compliance with Article 7 (d) We hereby certify “It is in compliance with the EEE Regulation”.
 (“EEE yönetmeliğine uygundur”)

Copy Regulations

United States

Congress, by statute, has forbidden the reproduction of the following subjects under certain circumstances. Penalties of fine or imprisonment may be imposed on those guilty of making such reproductions.

1. Obligations or Securities of the United States Government, such as:

Certificates of Indebtedness	National Bank Currency	Coupons from Bonds
Federal Reserve Bank Notes	Silver Certificates	Gold Certificates
United States Bonds	Treasury Notes	Federal Reserve Notes
Fractional Notes	Certificates of Deposit	Paper Money

Bonds and Obligations of certain agencies of the government, such as FHA, etc.

Bonds. (U.S. Savings Bonds may be photographed only for publicity purposes in connection with the campaign for the sale of such bonds.)

Internal Revenue Stamps. (If it is necessary to reproduce a legal document on which there is a canceled revenue stamp, this may be done provided the reproduction of the document is performed for lawful purposes.)

Postage Stamps, canceled or uncanceled. (For philatelic purposes, Postage Stamps may be photographed, provided the reproduction is in black and white and is less than 75% or more than 150% of the linear dimensions of the original.)

Postal Money Orders.

Bills, Checks, or Drafts of money drawn by or upon authorized officers of the United States.

Stamps and other representatives of value, of whatever denomination, which have been or may be issued under any Act of Congress.

2. Adjusted Compensation Certificates for Veterans of the World Wars.

3. Obligations or Securities of any Foreign Government, Bank, or Corporation.
4. Copyrighted material, unless permission of the copyright owner has been obtained or the reproduction falls within the “fair use” or library reproduction rights provisions of the copyright law. Further information of these provisions may be obtained from the Copyright Office, Library of Congress, Washington, D.C. 20559. Ask for Circular R21.
5. Certificates of Citizenship or Naturalization. (Foreign Naturalization Certificates may be photographed.)
6. Passports. (Foreign Passports may be photographed.)
7. Immigration Papers.
8. Draft Registration Cards.
9. Selective Service Induction Papers that bear any of the following Registrant’s information:

Earnings or Income	Dependency Status	Court Record
Previous military service	Physical or mental condition	

Exception: U. S. Army and Navy discharge certificates may be photographed.

10. Badges, Identification Cards, Passes, or Insignia carried by military personnel, or by members of the various Federal Departments, such as FBI, Treasury, etc. (unless photograph is ordered by the head of such department or bureau.)
11. Reproducing the following is also prohibited in certain states: Automobile Licenses — Drivers’ Licenses — Automobile Certificates of Title.

The above list is not all inclusive, and no liability is assumed for its completeness or accuracy. In case of doubt, consult your attorney.

Canada

Parliament, by statute, has forbidden the reproduction of the following subjects under certain circumstances. Penalties of fines or imprisonment may be imposed on those guilty of making such copies.

1. Current bank notes or current paper money.
2. Obligations or securities of a government or bank.
3. Exchequer bill paper or revenue paper.
4. The public seal of Canada or of a province, or the seal of a public body or authority in Canada, or of a court of law.
5. Proclamations, orders, regulations or appointments, or notices thereof (with intent to falsely cause same to purport to have been printed by the Queen’s Printer for Canada, or the equivalent printer for a province).
6. Marks, brands, seals, wrappers or designs used by or on behalf of the Government of Canada or of a province, the government of a state other than Canada or a department, board, Commission or agency established by the Government of Canada or of a province or of a government of a state other than Canada.
7. Impressed or adhesive stamps used for the purpose of revenue by the Government of Canada or of a province or by the government of a state other than Canada.

8. Documents, registers or records kept by public officials charged with the duty of making or issuing certified copies thereof, where the reproduction falsely purports to be a certified copy thereof.
9. Copyrighted material or trademarks of any manner or kind without the consent of the copyright or trademark owner.

The above list is provided for your convenience and assistance, but it is not all inclusive, and no liability is assumed for its completeness or accuracy. In case of doubt, consult your solicitor.

Other Countries

Copying certain documents may be illegal in your country. Penalties of fine or imprisonment may be imposed on those found guilty of making such reproductions.

- Currency notes
- Bank notes and cheques
- Bank and government bonds and securities
- Passports and identification cards
- Copyright material or trademarks without the consent of the owner
- Postage stamps and other negotiable instruments

Note: this list is not inclusive and no liability is assumed for either its completeness or accuracy. In case of doubt, contact your legal counsel.

Compliance Information

Product Recycling & Disposal

USA & Canada

If you are managing the disposal of your Xerox® product, please note that the product may contain lead, mercury, Perchlorate, and other materials whose disposal may be regulated due to environmental considerations. The presence of these materials is fully consistent with global regulations applicable at the time that the product was placed on the market. For recycling and disposal information, contact your local authorities. In the United States, you may also refer to the Electronic Industries Alliance web site: <http://www.eiae.org>.

Perchlorate Material - This product may contain one or more Perchlorate-containing devices, such as batteries. Special handling may apply, please see: <http://www.dtsc.ca.gov/hazardouswaste/perchlorate/>.

European Union

RoHS and WEEE Compliance

This product is compliant with RoHS Regulations of the European Parliament and Council Directive on the Restrictions of the Use of Certain Hazardous Substances in Electrical and Electronic Equipment (2002/95/EC), and with the Waste Electrical and Electronic Equipment (WEEE) Directive (2002/96/EC).

Some equipment may be used in both a domestic/household and a professional/business application.

Professional/Business Environment

Application of this symbol on your equipment is confirmation that you must dispose of this equipment in compliance with agreed national procedures. In accordance with European legislation, end of life electrical and electronic equipment subject to disposal must be managed within agreed procedures.



ENERGY STAR for the USA

Energy Program Compliance

The Xerox® DocuMate® 4830 is ENERGY STAR® qualified under the ENERGY STAR Program Requirements for Imaging Equipment.



ENERGY STAR and the ENERGY STAR mark are registered trademarks owned by the U.S. Environmental Protection Agency. The ENERGY STAR Imaging Equipment Program is a team effort between U.S., European Union and Japanese governments and the office equipment industry to promote energy-efficient copiers, printers, fax, multifunction machine, personal computers, and monitors. Reducing product energy consumption helps combat smog, acid rain and long-term changes to the climate by decreasing the emissions that result from generating electricity.

Xerox® equipment is preset at the factory. Your machine will be delivered with the timer for switching to Power Save Mode from the last scan set at 15 minutes.

