

XEROX[®]

DocuMate™ 272

DocuMate 272 **scanner** user's guide



XEROX[®]

DocuMate 272

DocuMate 272
scanner
user's guide



Copyright © 2007 Visioneer, Inc.

Reproduction, adaptation, or translation without prior written permission is prohibited, except as allowed under the copyright laws.

XEROX® is a trademark of Xerox Corporation in the United States and/or other countries and is used under license. DocuMate is a trademark of Xerox Corporation used under license. All other Xerox product names and product numbers mentioned in this publication are trademarks of Xerox Corporation.

The Visioneer brand name and logo are registered trademarks of Visioneer, Inc. The PaperPort and OmniPage® Pro brand names and logos are registered trademarks of Nuance Communications, Inc. Kofax® and Virtual ReScan® are registered trademarks, and VRS™ is a trademark of Kofax Image Products, Inc. QuickScan® is a trademark and ISIS is a registered trademark of Captiva Software Corporation. Adobe®, Adobe® Reader®, Acrobat® Reader®, Adobe® Acrobat®, and the Adobe® PDF® logo are registered trademarks of Adobe Systems Incorporated in the United States and/or other countries. The Adobe PDF logo will appear in this product's software, and full access to Adobe software features is only available if any Adobe product is installed on your computer. X1® Enterprise Client is a registered trademark of X1 Technologies, Inc.

Microsoft is a U.S. registered trademark of Microsoft Corporation. Windows is a trademark and SharePoint® is a registered trademark of Microsoft Corporation. ZyINDEX is a registered trademark of ZyLAB International, Inc. ZyINDEX toolkit portions, Copyright © 1990-1998, ZyLAB International, Inc. All Rights Reserved. All other products mentioned herein may be trademarks of their respective companies.

Information is subject to change without notice and does not represent a commitment on the part of Visioneer. The software described is furnished under a licensing agreement. The software may be used or copied only in accordance with the terms of such an agreement. It is against the law to copy the software on any medium except as specifically allowed in the licensing agreement. No part of this document may be reproduced or transmitted in any form or by any means, electronic or mechanical, including photocopying, recording, or information storage and retrieval systems, or translated to another language, for any purpose other than the licensee's personal use and as specifically allowed in the licensing agreement, without the express written permission of Visioneer.

Part Number: 05-0665-300

Restricted Rights Legend

Use, duplication, or disclosure is subject to restrictions as set forth in contract subdivision (c)(1)(ii) of the Rights in Technical Data and Computer Software Clause 52.227-FAR14. Material scanned by this product may be protected by

Table of Contents

Welcome

What's in the Box	1
The Xerox DocuMate 272 Scanner	2
What You Need	3
Documentation	3

Installation

Before You Begin	4
Step 1: Assemble the Scanner	5
Step 2: Install the Software	7
Step 3: Connect the Power Supply	13
Step 4: Connect the USB Cable and Turn on the Power	14
Additional Applications Available with Your Scanner	17
View the User Guides	19
Register Your Scanner and Check for Updates	21

Scanning

Load and Scan Documents	23
Check the Scan Settings Before Scanning	25
Scan from the One Touch Button Panel	26
Using the One Touch Button Panel	27
The Default One Touch Settings on Your Scanner	29
Scanning Identification Cards and Credit Cards	30
Configuring the One Touch Buttons	32
About the One Touch Properties Window	32
Selecting New Settings for a Button	35
Setting Destination Application Properties	37
Selecting Page Format Options	43
Renaming a One Touch Button	47
Selecting Options for a Button	48
Creating a New Scan Configuration	51
Editing or Deleting Scan Configurations	61
Configure Before Scan	63
Scanning with Optical Character Recognition (OCR)	66
Scanning with sPDF or nPDF and Searching for Text	68
Scan and Burn to a CD	70
Scanning with Event Forwarding	72
Creating an HTML Web Page from Your Scanned Documents	74
Transferring Scanned Documents to Storage	76
Checking the Hardware and Setting the Lamp Power Saving	79

Scanning with the TWAIN Interface from PaperPort

Accessing the TWAIN Interface from PaperPort	82
Getting Help with the PaperPort Software	84
Scanning with the TWAIN Interface	85
Scanning Plastic Cards from the TWAIN Interface	89
Display the Device Configuration	92
Setting Up PaperPort to Work With Your Scanner	93

Scanning with the WIA Interface

Fine Tuning Your Scans	100
------------------------------	-----

Scanning with the ISIS Interface

Accessing the ISIS interface in QuickScan	102
---	-----

Maintenance

Cleaning the Automatic Document Feeder	103
Clearing Paper Jams	104
Replacing the ADF Pad Assembly	105
Troubleshooting	106
Status Light Troubleshooting Codes	108
Uninstalling Your Scanner	110
Uninstalling the Scanner and One Touch Software	110
Uninstalling the PaperPort and OmniPage Software	110
To Install Another Driver	111
Xerox DocuMate 272 Scanner Specifications	112
Xerox DocuMate 272 Scanner Parts List	113

Notices

It's Illegal in the USA	115
It's Illegal in Canada	116
Federal Communications Commission (FCC) for USA	117
Energy Star for the USA	118
RoHS and WEEE Compliance	118
Product recycling and disposal for USA	118

Index

.....	119
-------	-----

Welcome

Your new Xerox DocuMate 272 scanner can quickly scan single-sided or double-sided stacks of documents and place their images on your computer.

What's in the Box

Before proceeding, check the contents of the box. If items are missing or damaged, contact the dealer where you purchased the scanner.



DocuMate 272 Scanner



Paper Guide

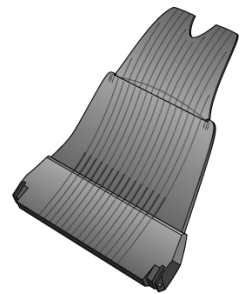

Output Tray



USB Cable



Power Cord



Power Supply

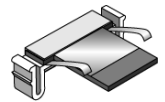

Replacement ADF Pad



Installation DVD

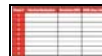

Buttons Label

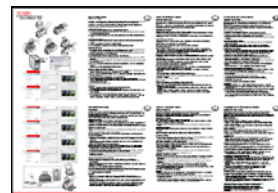

Quick Install Guide



Technical Support Card

The Xerox DocuMate 272 Scanner

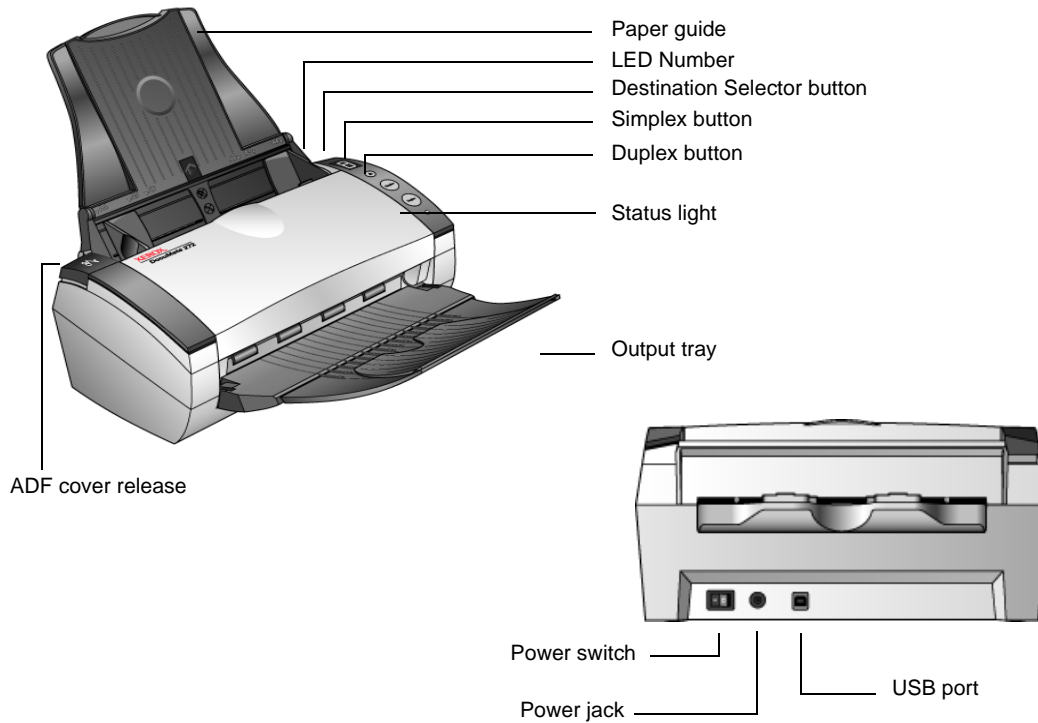

Paper guide—Holds documents in place. Adjusts to fit the document width.

LED Number—Shows the current scan setting for the Simplex and Duplex scanning buttons. A scan setting includes resolution, file type, brightness, color or black and white, destination, and so on.

Destination Selector button—Selects the scan setting for the Simplex and Duplex buttons. Press to cycle through the nine settings.

Simplex button—Press to scan a one-sided document.

Duplex button—Press to scan a two-sided document.

Status light—Shows the scanner's status. A steady green light indicates the scanner is available to scan. A rapidly flashing green light indicates the scanner is preparing to scan. Refer to the Troubleshooting section for additional details.

Output tray—Holds documents after scanning through the Automatic Document Feeder (ADF).

ADF cover release—Opens the cover on the ADF.

Power switch—On/Off power switch.

Power jack—Connects the power cord to the scanner.

Universal Serial Bus (USB) port—Connects the scanner to the computer.

What You Need

IBM-compatible Pentium 4 PC, or AMD equivalent with:

- A DVD-ROM drive
- An available Universal Serial Bus (USB) port
- Microsoft Windows operating system: 2000 (Service Pack 4), XP (Service Pack 1 and 2), or Vista
- *Windows 2000 and XP:* Minimum of 512 megabytes (MB) of internal memory (RAM)
Windows Vista: Minimum of 1 gigabyte (GB) of internal memory (RAM)
- 350 MB minimum of free hard disk space

A VGA or SVGA Monitor

The recommended settings for your monitor are:

- High Color (16-bit) or True Color (24-bit or 32-bit)
- Resolution set to at least 800 x 600 pixels

To set your monitor's colors and resolution:

- Open the Windows Control Panel
- Double-click on **Display** then select the **Settings** tab

Documentation

The following documentation is provided with your scanner:

- Quick Install Guide—Abbreviated installation instructions.
- Xerox DocuMate 272 Scanner User's Guide—On the Installation DVD; contains detailed installation, scanning, configuration, and maintenance information.
- PaperPort User's Guide—On the Installation DVD; contains detailed feature and configuration information for the PaperPort software.
- Online Help—For the scanner configuration, TWAIN and WIA interfaces, and PaperPort software application.

Installation

Installation is a quick, four-step process:

1. Assemble the scanner
2. Install the software
3. Connect the power supply
4. Connect the USB cable and turn on the power

Before You Begin

Please make sure of the following before you begin installation:

- **The information in this guide may cover software not provided with the scanner you purchased. Disregard any information about the software not applicable to your chosen product. Please visit our web site at www.xeroxscanners.com for the latest software updates for your Xerox DocuMate 272 scanner.**
- **If your computer has AntiVirus or AntiSpyware software running, you may see messages during installation asking you to allow the installation to proceed. Although the messages will differ based on the software your computer is running, in each case you should allow the installation to proceed. Alternatively, you can turn off the AntiVirus or AntiSpyware software before installing your scanner. But if you do, make sure to turn it back on again when installation is finished.**
- **If you already have a scanner connected to your computer, you may need to remove its driver programs to properly install and operate your Xerox DocuMate 272 scanner. Please see “Troubleshooting” on page 106 for more information, and “Uninstalling Your Scanner” on page 110 for basic instructions to uninstall driver programs. Also see the User’s Guide that you received with your other scanner for specific instructions.**
- **If your computer is running Windows Vista, you may see the Vista User Access Control screen asking you to confirm system changes. Click the continue button to allow the installation to proceed.**

Step 1: Assemble the Scanner

To assemble the scanner:

1. Remove all shipping tape from the top and bottom of the scanner.
2. Carefully remove the protective foam from the ADF cover release, then press the release and open the Automatic Document Feeder cover.

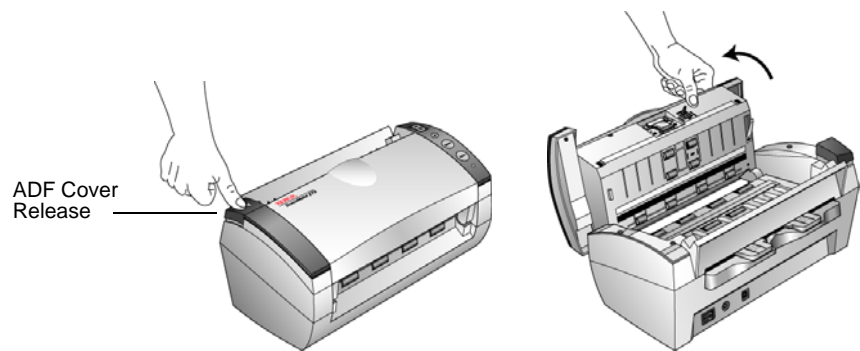

3. Carefully remove any foam particles that may have gotten inside the document feeder, and close the cover.
4. Align the slots on the paper guide with the ridges on the scanner and slide it down until it snaps into place.



5. Insert the pins on each side of the output tray into the holes on the scanner.

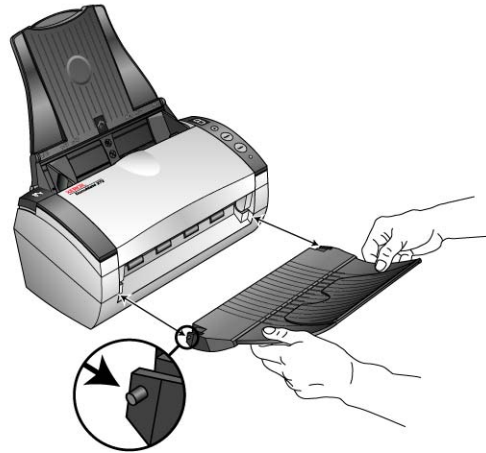

6. Flip open the extension on the output tray so it is fully extended.

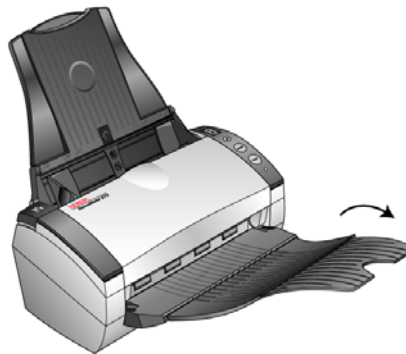

7. Proceed to “Step 2: Install the Software.”

Step 2: Install the Software

To install the software:

1. Start Microsoft Windows and make sure no other applications are running.
2. Insert the installation DVD into your computer's DVD-ROM drive.



The DVD automatically starts.

NOTE: If the DVD does not start, check the following:

- Make sure the DVD drive's door is completely shut.
- Make sure the DVD was inserted in the drive in the proper direction (label side up).

To launch the DVD manually:

- Open the Windows option for My Computer. You can do this by double-clicking on the **My Computer** icon on your desktop.
- Double-click the icon for your DVD-ROM drive.
- The Installation menu for the DVD should now open.

If the menu does not open:

- From the list of files on the DVD, double-click the file named START32.EXE.

3. On the Installation menu, select **Install Products**.

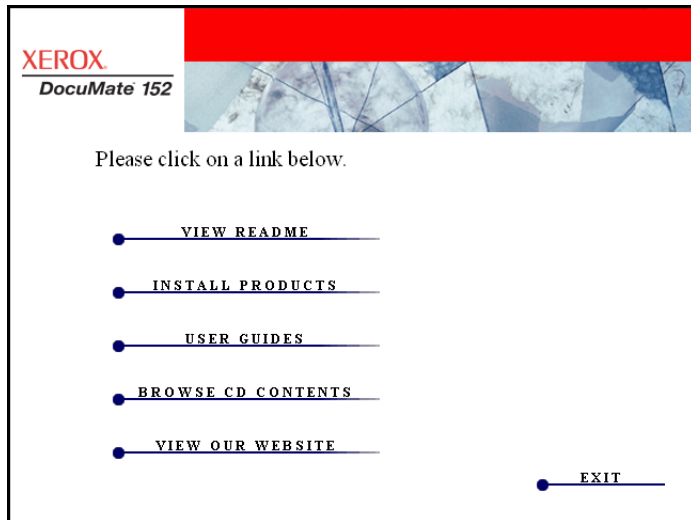

4. Make sure the boxes for **Nuance PaperPort®** and **Scanner Driver** are checked.

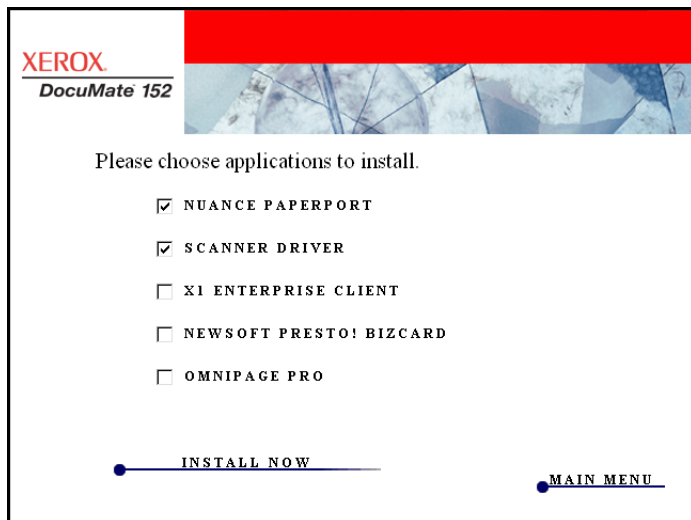

NOTE: The software provided with your scanner may differ slightly from the list shown in the window.

5. Click **Install Now**.
6. The Select Language window opens. Click the drop-down menu arrow and select the language to use. Click **OK**.

The first PaperPort Installation window opens.

1. On the PaperPort Welcome window, click **Next**.

Installing PaperPort will uninstall any existing version of PaperPort and will install the newer version. Your existing PaperPort files will not be affected.

2. Read the PaperPort license agreement and select **I accept the terms in this agreement** then click on **Next**. If you choose not to accept the license agreement, the installation will terminate and the PaperPort software will not be installed.
3. On the Customer Information window, accept the current values or enter new information, then click **Next**.
4. On the Setup Type window, keep the default Setup Type and click **Next**.
5. Click **Install** to begin the installation.

Reminder: If your computer is running an AntiVirus or AntiSpyware application, you may see messages asking you to allow installation. Select the option to allow installation to proceed.

6. On the Product Registration window, do one of the following:
 - Select **Register online**, click **OK**, then follow the registration instructions.
 - Select **Print registration form**, click **OK**, then follow the instructions to complete and print the registration form.
 - Select **Remind me in 7 days** and click **OK**.
7. At the InstallShield Wizard Completed window, click **Finish**.

If a message window opens instructing you to restart your computer, click **Restart**.

The Welcome to the One Touch 4.0 Setup Wizard opens.



1. Click **Next**.
2. On the Xerox License Agreement window, read the license agreement. If you accept the terms, select **I Agree** then click **Next**.

If you choose not to accept the license agreement, the installation will terminate and the scanner driver will not be installed.

The next window lists the choices of the drivers that you can install for your scanner.

Note: Some of the options listed in this window may not be available when you purchase your scanner.

Please visit our web site at: www.xeroxscanners.com for the latest updates.

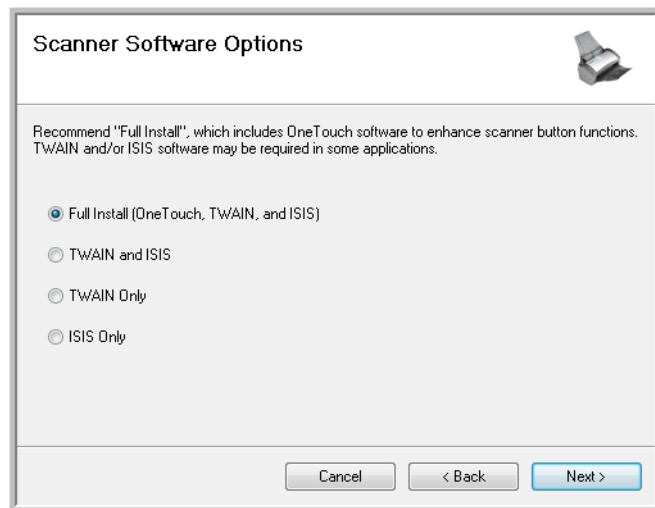

3. Select the option you want.

NOTE: If your computer is running Windows XP or Windows Vista, Microsoft's Windows Image Acquisition (WIA) interface for scanning is always available, regardless of your selection on this window.

- **Full Install (OneTouch, TWAIN and ISIS)**—This is the **recommended** installation. It installs the One Touch 4.0 software which provides the necessary driver software for the scanner. It also installs scanning interfaces for the TWAIN and ISIS drivers. Installing this option means that you can use several different methods to scan, as explained in this User Guide.
- **TWAIN and ISIS**—The TWAIN and ISIS drivers are installed. The One Touch 4.0 Monitor will not run and you cannot use the One Touch features. You can use the Xerox DocuMate 272 TWAIN driver to scan from applications with a TWAIN interface. You can also scan from applications that use the ISIS driver. You will not be able to scan with the buttons on the scanner.
- **TWAIN only**—The TWAIN driver is installed without the One Touch 4.0 software or the ISIS driver. You can use the Xerox DocuMate 272 TWAIN driver to scan from TWAIN applications. You will not be able to scan with the buttons on the scanner.
- **ISIS only**—The ISIS driver is installed. You can use applications that use the ISIS driver such as Kofax and QuickScan. The One Touch 4.0 Monitor will not run and you cannot use the One Touch features. You will not be able to use the Xerox DocuMate 272 TWAIN driver. You also will not be able to scan with the buttons on the scanner.

NOTE: If you decide to change the scanner's installed drivers later on, you must first uninstall the drivers the scanner is currently using. See the section "To Install Another Driver" on page 111.

4. Click **Next**.

During installation you will see this window asking you to select one of the images for your Color Space setting.

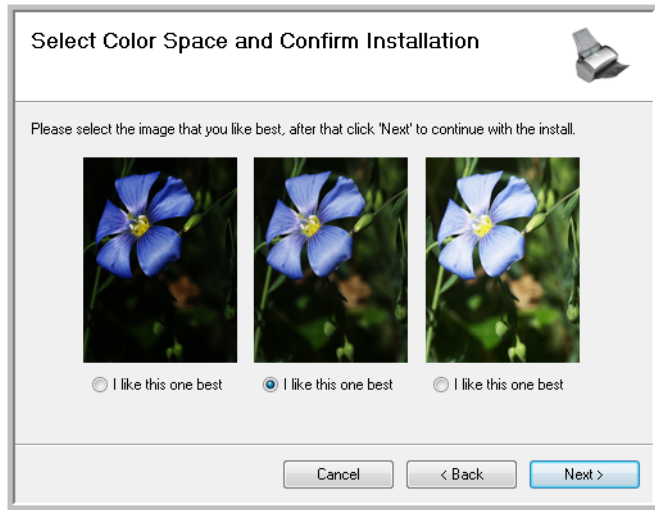

The Color Space setting sets the gamma value for the scanner so scanned items look good on your monitor. Gamma controls the brightness of the midtones of colors. That setting can be changed later as you're scanning.

5. Select the option that looks best to you and click **Next**.

The driver installation will now begin.

6. **STOP** when you see the "Complete the installation by connecting your hardware" window. Do **NOT** click **OK** yet. Leave the window open and proceed to the next section, "Step 3: Connect the Power Supply."

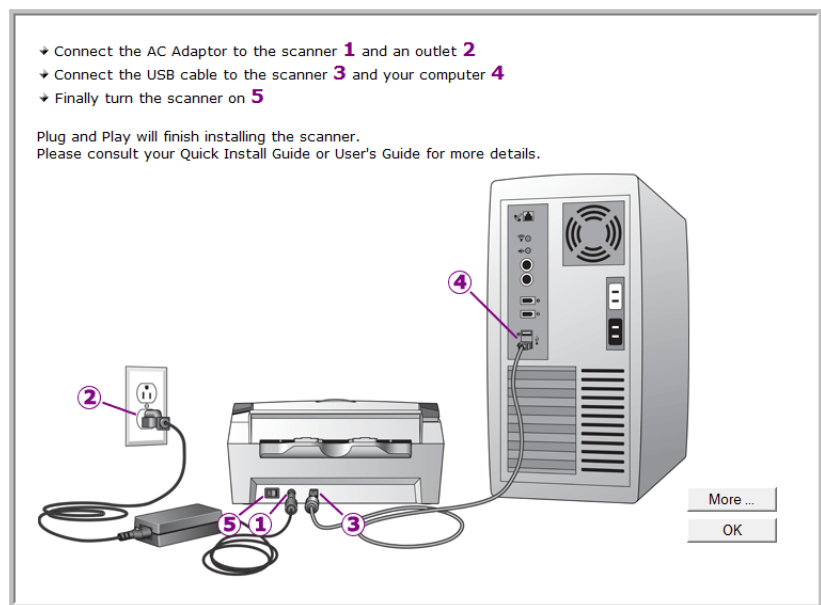

Step 3: Connect the Power Supply

Connect the power supply and power cord, and plug the power supply into an electrical outlet.

To connect your DocuMate 272 scanner:

1. Plug the power supply into the power port on the scanner.

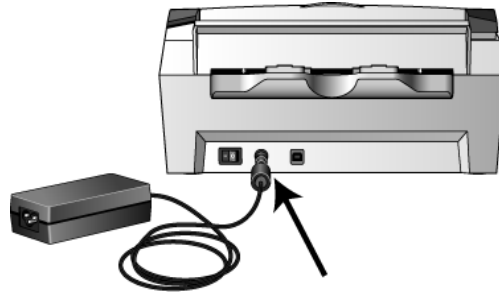

NOTE: Only use the power supply (HEG42-240200-7L made by HiTron) included with your scanner. Connecting any other type of power supply may damage your scanner, and will void its warranty.

2. Plug the power cord into the power supply and into a wall outlet.

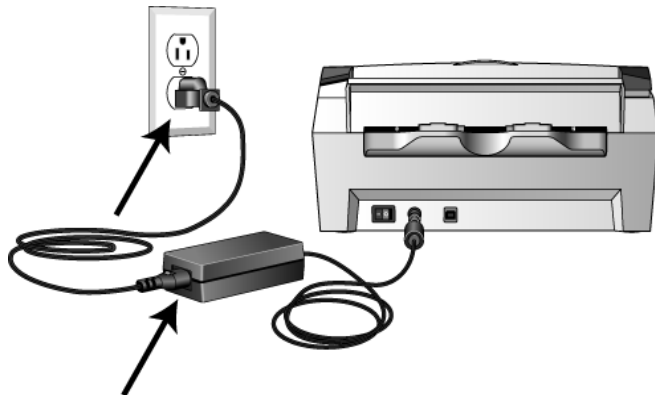

Now proceed to the next section, “Step 4: Connect the USB Cable and Turn on the Power.”

Step 4: Connect the USB Cable and Turn on the Power

The DocuMate 272 scanner connects to any available USB port. Check your computer's manual for USB port locations.

NOTE: You can connect the scanner to your computer while the computer is running. You do not have to shut down your computer.

1. Remove any protective tape from the USB cable.
2. Plug the USB cable into the USB port on the scanner then into a USB port on the computer. Connection to a USB 2.0 High Speed port provides optimum performance, however your scanner will also connect to a USB 1.1 port.

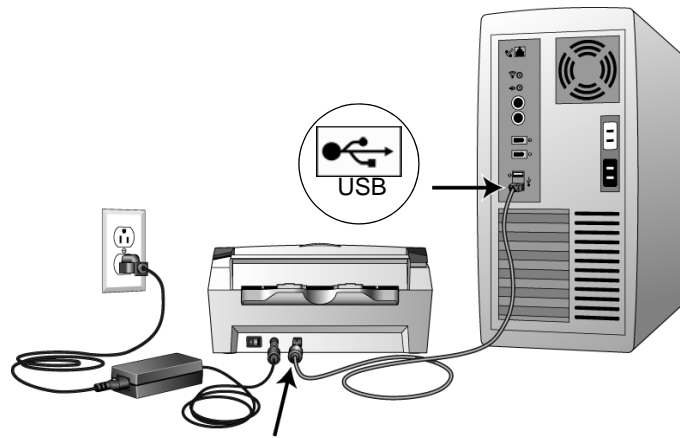

The USB symbol, as seen in the above diagram, identifies the location of the USB port on your computer. If the plug does not attach easily, make sure that you are plugging it in correctly. Do not force the plug into the connection.

You can also connect the scanner to a USB port on the computer's keyboard if it has one, or to a USB hub. If you use a USB hub, it must have its own power supply already plugged into an electrical outlet.

3. Turn on the power switch, located on the back of the scanner to the left of the power port.

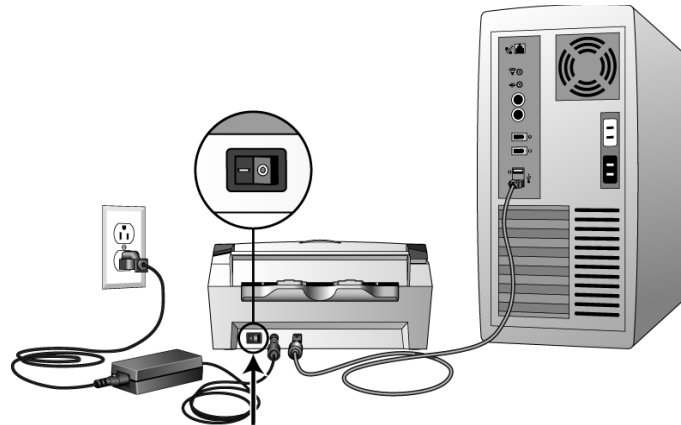

The status light comes on and flashes indicating that the scanner is receiving power.

If you are using Windows XP and have plugged the USB cable into a USB 1.1 port, an information bubble may open explaining that “A HI-SPEED USB device is plugged into a non-HI-SPEED USB hub”. Plug the USB cable into a USB 2.0 port (if available) or just disregard the message. If you leave it plugged into the USB 1.1 port, your scanner may scan a bit slower than the 25 pages per minute, and 50 images per minute available with a USB 2.0 port.

Your computer then recognizes that a scanner has been plugged into the USB port and automatically loads the appropriate software to run the scanner.

Do not proceed until you receive a message that your computer has found the new hardware, or updated the driver database. If your computer is running Windows XP or Windows Vista, you will see a message similar to the following.

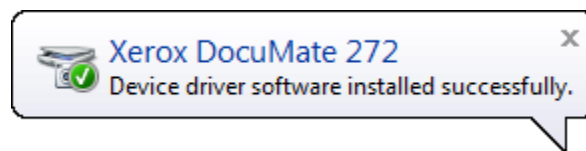

4. When you're certain that the software has completely loaded, return to the "Complete the installation by connecting your hardware" window.

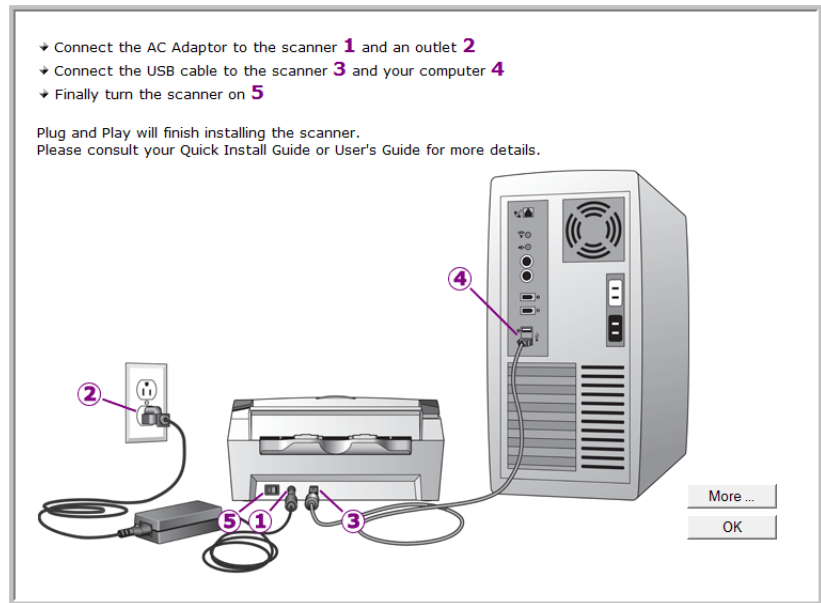

5. Click **OK**.

You can also click **More** to see a quick overview about accessing and navigating the One Touch Button Panel. When you're finished reading the additional information, click **OK**.

The scanner's status light is green when the scanner and computer are communicating properly.

6. Click **Close** on the Installation Complete window to close and exit the software installer.

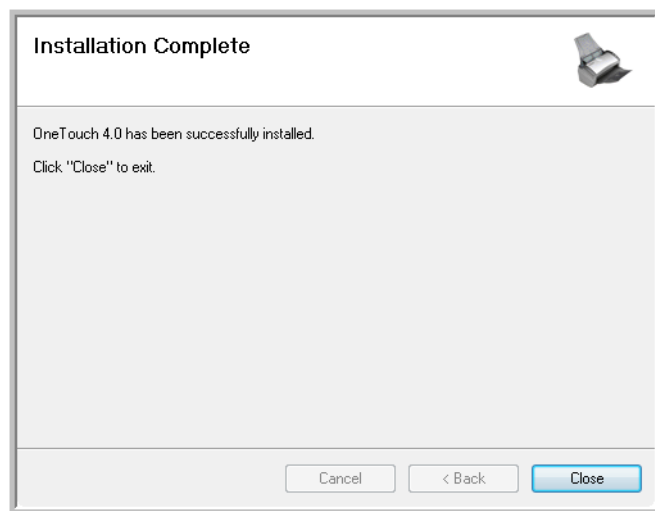

You can now install the additional applications you received with your scanner.

Additional Applications Available with Your Scanner

Your scanner includes free, additional applications on the installation DVD.

1. Reinsert the installation DVD into the DVD-ROM drive.
The Installation menu opens.

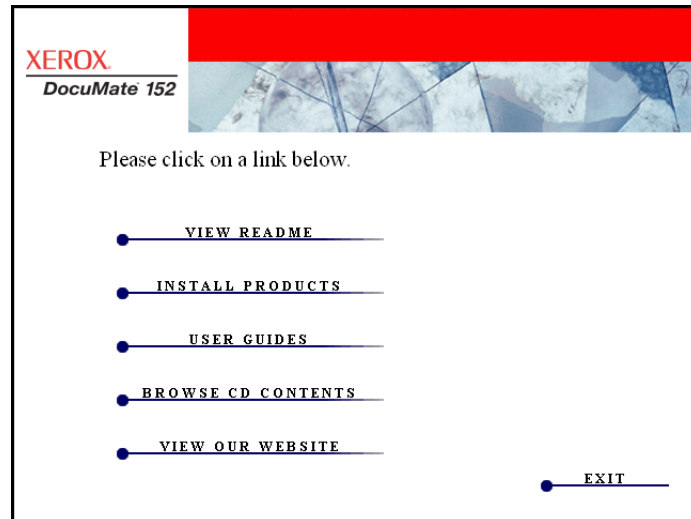

The free Adobe Acrobat Reader software is located on the DVD with the User Guides. See the steps on page 20 to install Adobe Acrobat Reader.

2. Click **Install Products**.

You will see the screen that shows the applications. Applications already installed have *Installed!* next to them.

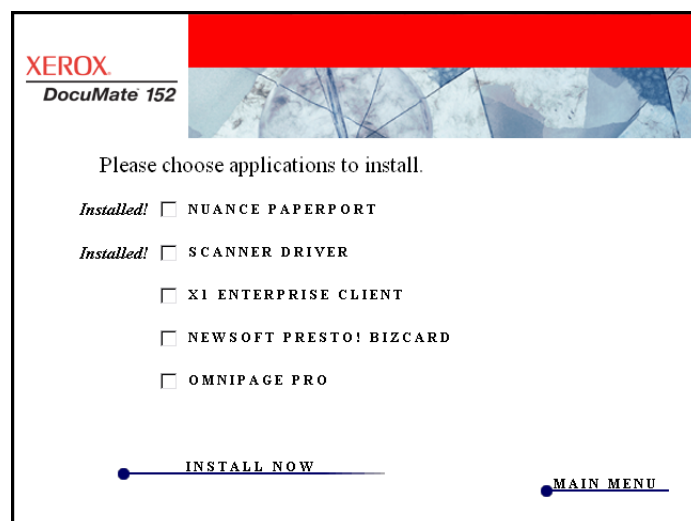

3. See the following table to decide which software you would like to install.

- On the window shown above, click in the boxes of the other software you want to install, and click **Install Now**. Follow the instructions on the screen to install each of the additional products.

Software	About the Software
Adobe® Acrobat Reader®	Adobe Acrobat Reader is a stand-alone application that you use to open, view, search, and print PDF files. The User Guides on your scanner's installation DVD are in PDF format and require Adobe Acrobat Reader for you to view and save them.
QuickScan™	A desktop imaging solution for scanning, image enhancement, and OCR, QuickScan is a standalone, out-of-the-box imaging solution that provides all the necessary capabilities for high-speed scanning, image enhancement, viewing, annotation, printing, and storing images, for both black-and-white and color pages. It uses an ISIS-certified driver for scanning, and includes flexible job separation and barcode recognition. The Demo version lets you try the application first. You can use this software as an additional method to scan.
Kofax® VRS® and Kofax® Scan Demo	Kofax VRS automatically enhances scanned documents from less than perfect originals. It is an additional scanning interface that uses patented VRS (Virtual ReScan) technology, and ensures your scanning is as efficient and easy as possible, while also improving both the quality of the scanned images. Kofax VRS uses an ISIS-certified driver for scanning. This software provides an additional method to scan from your scanner. The Scan Demo version lets you try the software first.
<p>If you install the Kofax VRS software, you may see the following message.</p>	
<div style="text-align: center;">  </div>	
<p>Please disregard this message and click OK. The Kofax VRS Certified ISIS® driver is installed correctly when you install your Xerox DocuMate 272 scanner.</p>	
OmniPage®	OmniPage Pro provides precision OCR analysis, advanced layout detection, and Logical Form Recognition™ (LFR) technology. Advanced security features quickly turn office documents and forms into over 30 different PC applications for editing, searching and sharing. Custom workflows handle large volumes of documents, and you can use its tools to print to PDF. OmniPage Pro also includes ScanSoft PDF Create!® and PDF Converter programs.
X1® Enterprise Client	X1 is a desktop search engine software. Using a single interface, the X1 Enterprise Client software will quickly and efficiently find files and emails stored on your computer.

View the User Guides

1. To get the documentation for each of the additional products, return to the Main Menu window and click User Guides.
2. The User Guides window opens. Use this window to view and save the User Guides you want.

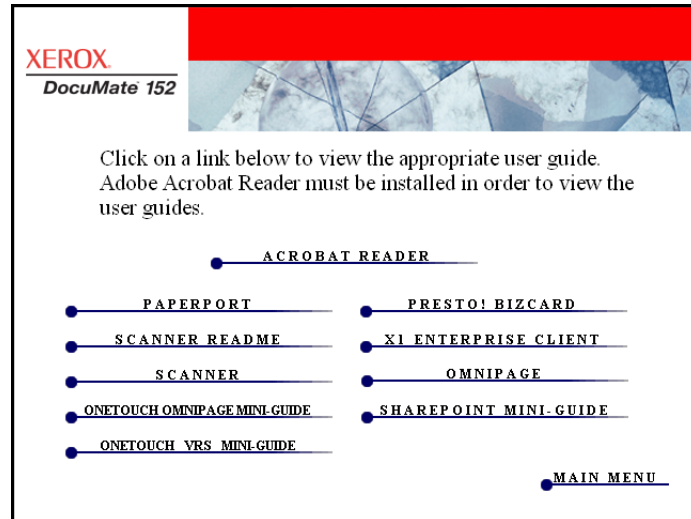

3. The User Guides are in Adobe® Acrobat® PDF format. The DVD also includes a free copy of Acrobat® Reader® in case your computer does not have it already installed. The Scanner Readme file is in HTML format and will open in any standard browser.

If you need to, click **Acrobat Reader** to install it now. Follow the instructions on the installation windows.

If your computer already has Adobe Acrobat Reader installed, please do not select it unless the version provided on the installation DVD is a newer version than the one currently installed on your computer.

To view and save the User Guides:

1. Click the name of a User Guide you want to view and it will open in Acrobat Reader. Use the Acrobat Reader **Save** command to save that User Guide on your computer.
2. Return to the User Guides window and repeat the process to open, view, and save all the other User Guides you want. **The Scanner Readme file has late-breaking news about your scanner.**
 - The SharePoint Mini-Guide has information about a new feature in the One Touch 4.0 software to link to Microsoft's SharePoint application. This brief Mini-Guide explains how to setup the SharePoint link and use the SharePoint features when choosing new scan settings for your scanner.
 - The One Touch VRS Mini-Guide has information about a new feature in the One Touch 4.0 software. This brief Mini-Guide explains what the feature is and how to use the VRS settings when creating or modifying a scan configuration.
 - The One Touch OmniPage Mini-Guide has information about a new feature in the One Touch 4.0 software. This brief Mini-Guide explains what the feature is and how to use the OmniPage settings when creating or modifying scan configurations.
3. When you're finished, click **Main Menu** to return to the Main Menu window and click **Exit**.
4. Remove the DVD and store it in a safe place.

That's it! Installation is finished and your Xerox DocuMate 272 scanner is ready to scan.

Register Your Scanner and Check for Updates

Registering your scanner is important as it provides you with access to free telephone support service. Registration also gives you free access to software updates for your scanner.

To register your scanner:

1. Right-click on the One Touch icon in the Windows Notification Area (at the bottom right corner of the screen).

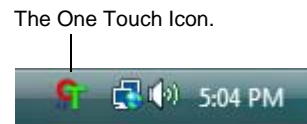

2. Choose **Check for Online Updates** from the pop-up menu.

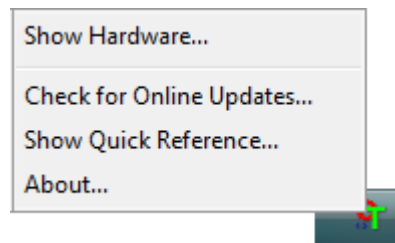

3. Follow the instructions on the screen and register your scanner by entering your scanner's serial number and your email address.

NOTE: A valid email address is required.

The serial number is located on the underside of the scanner.

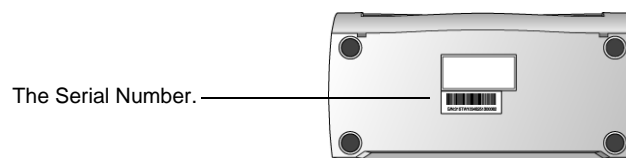

After registration is complete you will receive an email message with your RegID.

Your RegID is important as you will need it when accessing free telephone support, or checking for online updates.

4. After receiving your RegID, write it down on a piece of paper and keep it with your scanner so you will be able to find it easily.

Scanning

If you selected the recommended Full Install option (see page 11), then you have several different options to scan with your Xerox DocuMate 272 scanner. Each method scans equally well, so use the one with appropriate options for the item you are scanning.

NOTE: During installation, the One Touch 4.0 software searches your computer and links to all the applications (known as the Destination Applications) where it can send and open scanned documents. To make sure that all the Destination Applications are linked to One Touch 4.0, Xerox recommends that you refresh One Touch 4.0 before using your scanner for the first time. Please see “Check the Scan Settings Before Scanning” on page 25 for the steps to Refresh One Touch 4.0.



- **Scanner Buttons**—When you press either the Simplex or Duplex button, documents are scanned using the scan settings indicated by the LED number. The scanned images are then sent to a software application on your computer. See “Load and Scan Documents” on page 23.
- **One Touch**—Use this scan option when you want to scan from the computer screen. Open the One Touch scan panel and window, adjust the scan settings if you want, put the document in the scanner, then click the icon on the One Touch panel. Also use this One Touch method of scanning if you want to access the advanced features of Optical Character Recognition (OCR) available from the OmniPage Pro application. See “Scan from the One Touch Button Panel” on page 26.
- **TWAIN Interface**—This option uses your scanner’s TWAIN interface to scan. Select scanning options before scanning, put the document in the scanner, then click a button on the TWAIN interface window. See “Accessing the TWAIN Interface from PaperPort” on page 82.
- **Windows Image Acquisition (WIA)**—This option uses the Microsoft Windows set of choices for scanning. Select the WIA scan settings, put the document in the scanner, then click a button on the WIA window. Scanning with WIA is only available if your computer is running Windows XP or Windows Vista. See “Scanning with the WIA Interface” on page 98.
- **ISIS Interface**—This option uses the ISIS interface for scanning. Select the ISIS scan settings, put the document in the scanner, then click a button on the ISIS window. See “Scanning with the ISIS Interface” on page 102.

Load and Scan Documents

When you press either the Simplex or Duplex button, documents are scanned using the scan settings indicated by the LED number. The scanned images are then sent to a software application (known as the Destination Application) on your computer.

1. Adjust the paper guide for the width of paper, and make sure the input and output trays are fully extended.

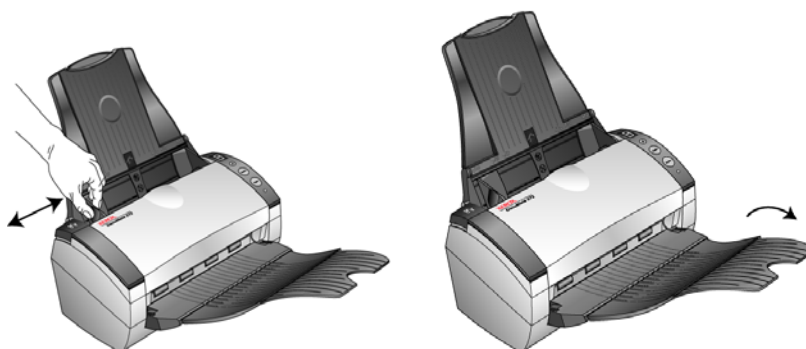

NOTE: Always remove any staples or paper clips from documents before inserting them into the scanner's Automatic Document Feeder. Staples and paper clips can jam the feed mechanism and scratch the internal components. Also remove any labels, stickers, or Post-It™ notes that may come off during the scanning process and get stuck in the scanner. Misuse as described here will void your scanner's warranty.

2. Load the documents with their tops into the Automatic Document Feeder.

For Simplex (one-sided) scans, load the documents *face down*.

For Duplex (two-sided) scans, the documents can be face up or down because both sides are scanned.

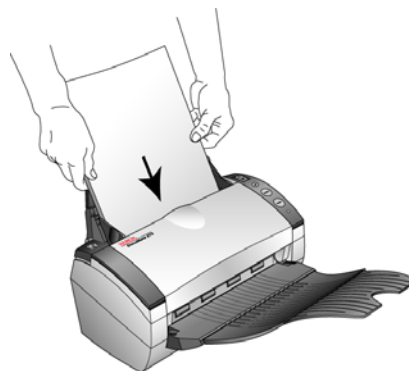

3. Check the LED number to make sure you're using the scan setting you want.

To choose a new scan setting, press the Destination Selector buttons.

The current scan setting. See "Check the Scan Settings Before Scanning" on page 25 to check the settings.

Press the Destination Selector to cycle through the scan settings to select the one you want.

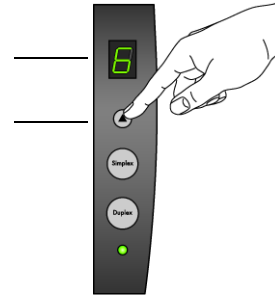

4. To scan a one-sided document, press the **Simplex** button.
To scan a two-sided document, press the **Duplex** button.



A scan progress window opens and the image is sent to the selected application from the One Touch utility. In this example of duplex (two-sided) scanning, the Destination Application is the PaperPort desktop and the two pages are stacked, one on top of the other.

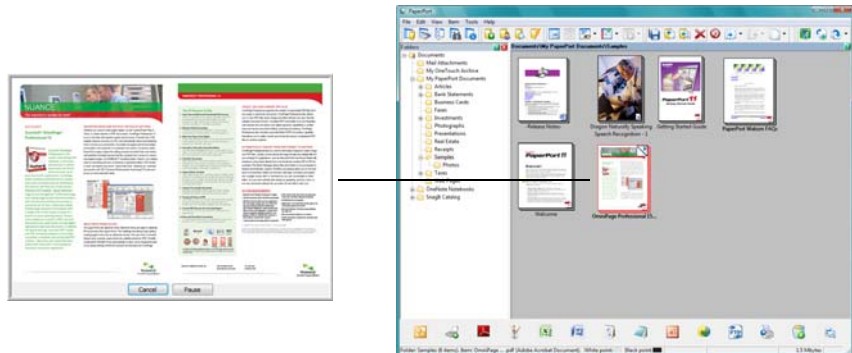

To Cancel scanning, click the **Cancel** button.

Check the Scan Settings Before Scanning

1. To check the scan settings before scanning, *press, hold down, and then release*, either the **Simplex** or **Duplex** button.

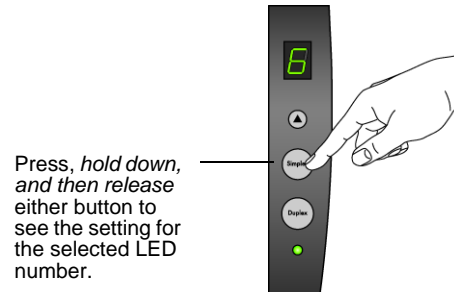

The One Touch Properties window opens for you to view and change the settings before scanning. This sample shows the current description of setting 6.

Note: The configurations shown on this example of the One Touch Properties window are for illustration purposes only. The configurations you see on your One Touch Properties window may be different.

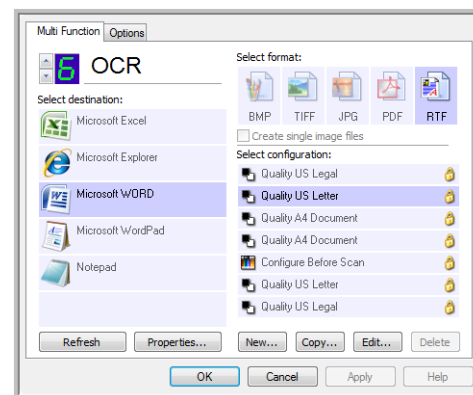

The One Touch Button Panel also opens with the description of the selected settings.

To Refresh the One Touch 4.0 settings, click the **Refresh** button.

If you make changes in the One Touch Properties window, then click the **Apply** button, the information in the One Touch panel will update to show the new settings.

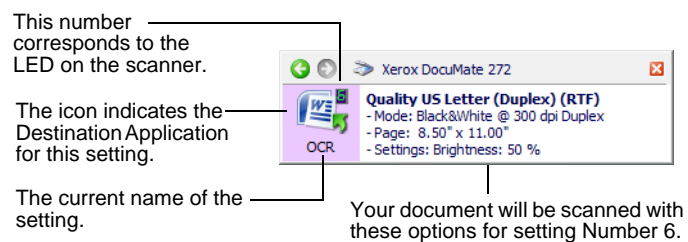

2. When you are ready to scan, press either the **Simplex** or **Duplex** button, or click **OK** to close the window then click the button on the One Touch Button Panel.

Scan from the One Touch Button Panel

You can scan from the One Touch Button Panel on the screen.

1. Adjust the paper guide for the width of paper and load the documents with their tops into the Automatic Document Feeder.

For Simplex (one-sided) scans, load the documents *face down*.

For Duplex (two-sided) scans, the documents can be face up or down because both sides are scanned.

2. Now click on the One Touch icon in the Windows Notification Area (at the bottom right corner of the screen).

The One Touch Icon.



The One Touch Button Panel opens and shows the first five on-screen scanning buttons. Click the arrows to cycle through all 9 settings.

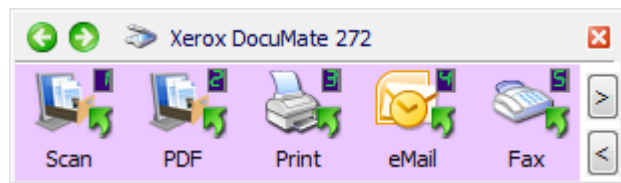

Click the button you want to use to scan.

Click these arrows to navigate through the 9 buttons.

3. On the screen—not on the scanner—click the button you want to use to scan.

NOTE: The One Touch Properties window must be closed before you can scan from the Button Panel.

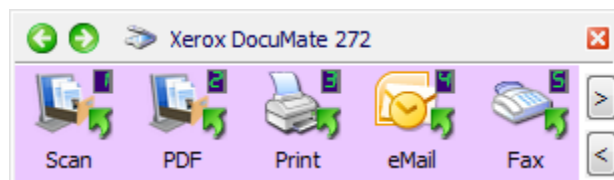

For example, if you want to scan with button 2, which converts the document to PDF, click here.

Or if you want to scan with button 4, which attaches the scanned document to a blank email message, click here.

NOTE: Your scanner comes with 9 factory-preset One Touch button settings. You can reconfigure and rename all the buttons.

The scanner begins scanning. When the process finishes, the scanned images appear in the Destination Application, just as if you scanned with the Simplex or Duplex scanner buttons.

Using the One Touch Button Panel

The One Touch Button Panel is also your on-screen set of controls for the scanner. The One Touch Button Panel shows information about the scanner and its settings.



1. To open the One Touch Button Panel, click the One Touch icon. It is located in the Windows Notification Area at the bottom right corner of the screen.

The One Touch Button Panel opens at its Button View, which shows the on-screen scanning buttons.

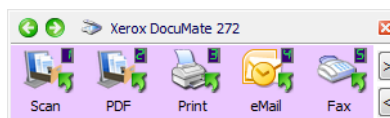

The Button View.

2. To scan from the panel, click the icon you want to use to scan.

NOTE: The One Touch Properties window must be closed before you can scan from the Button Panel.

3. To see the detailed settings for a button prior to scanning, click on the green arrows to navigate through the panel's three views.

Click these arrows to navigate through the panel's three views.

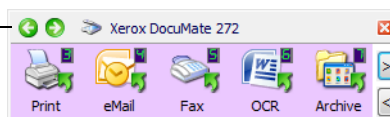

The Button View.

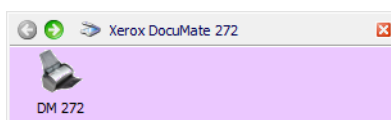

The Hardware View.

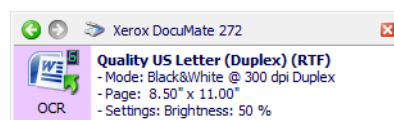

The Detail View.

- The Button View is your main scanner control panel. Use it to scan or to see all nine buttons.
- The Detail View shows the current scan settings for a button.

If the Properties window is not open, right-click the icon on the Detail View or Button View to open it.

- The Hardware View shows the current scanners connected to your computer.

From the Hardware View and Detail View, click the green arrow to return to the Button View. You can also click on the hardware icon to return to the Button View.

- To cycle through the nine buttons, click the arrows on the right side of the panel.

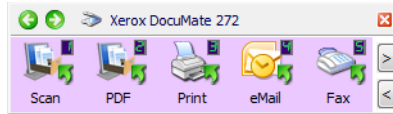

— Click these arrows to cycle through the 9 buttons.

- To close the One Touch Button Panel, click the close button on the panel.

About the One Touch Button Panel's Names and Icons



eMail

The button names, such as PDF, eMail or Fax, indicate the original factory settings for a button. For example, the eMail button is set up to scan documents then immediately attach them to a new eMail message in your eMail program. But you can change the name, the Destination Application, and any of the other aspects of the button.

A question mark for a button means your computer does not have appropriate software for the initial factory settings. In that case, you would probably want to change the name and Destination Application to something else. For example, if you scan a lot of documents that have faint images, such as hand-drawn sketches in light pencil, you might want to change the button's name to Sketches, and the Destination Application to Microsoft Paint®, or some other drawing program.

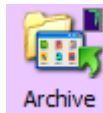

Archive

A folder icon for a button, such as shown for button 7, means that the scanner sends the scanned image to the default folder at **C:\Documents and Settings\\My Documents\My OneTouch Archive\PDF Documents** without first opening it in a Destination Application. To see the scanned image, open the file using the appropriate application for the file's format. The file will be named with the current date.

See "Configuring the One Touch Buttons" on page 32 to change the settings of the buttons on the One Touch Button Panel.

The Default One Touch Settings on Your Scanner

Based on the recommended install of PaperPort and the scanner driver, your scanner is pre-configured to scan items for various basic tasks, such as email or fax, then send the scanned image to an appropriate, pre-selected Destination Application. The following table shows these factory-default settings. *You can change any of these settings.*

If PaperPort, OmniPage or One Touch OmniPage is not installed, then the options for sending to word processing applications such as Microsoft Word will not be available.

Button	Name	Destination Application	Preconfigured Settings
1	Scan	PaperPort	Black&White @ 200dpi Duplex
2	PDF	PaperPort	Black&White @ 200dpi Duplex
3	Print	Printer	Black&White @ 200dpi Simplex
4	eMail	eMail Application	Black&White @ 200dpi Simplex
5	Fax	Fax Application	Black&White @ 200dpi Simplex
6	OCR	Microsoft Word	Black&White @ 300dpi Duplex
7	Archive	Transfer to Storage	Black&White @ 300dpi Simplex
8	Custom	Microsoft Paint	Color @ 100dpi Simplex
9	Paint	Microsoft Paint	Color @ 300dpi Simplex

NOTE: The default page size in each configuration is based on the location selected in your Windows setup.

For example:

- If the Windows location is set to “United States”, the default page size in each profile is based on the United States standard page sizes such as 8.5”x11”.
- If the Windows location is set to “United Kingdom”, the default page size in each profile is based on the ISO 216 standard and the majority of the profiles will default to A4.

NOTE: The email application will default to the email program specified in the internet options of Internet Explorer.

Scanning Identification Cards and Credit Cards

Your **Xerox DocuMate 272** scanner has a specially designed card feeder for scanning plastic identification cards, insurance cards and credit cards.

The steps below explain how to scan using the One Touch scanner buttons or One Touch button panel. See “Scanning Plastic Cards from the TWAIN Interface” on page 89 for the steps to use the TWAIN interface.

NOTE: If paper is in the Automatic Document Feeder, the card reader will not scan a card. The document feeder must be empty when scanning cards.

1. Insert the card lengthwise into the Card Reader slot on the back of the scanner.



2. To scan, press either the Simplex or Duplex button on the front of the scanner or click on a button on the One Touch button panel.

Scan using One Touch Buttons:

Press the Destination Selector to cycle through the scan settings to select the one you want for scanning the card.



Press the Simplex or Duplex scanner button.

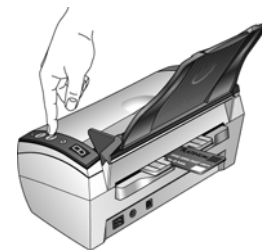

Scan using One Touch Button Panel:

Click these arrows to scroll to the application you want to send the card scan to.

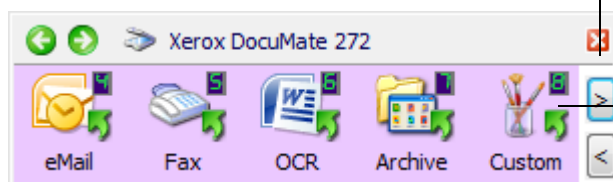

Then click the button to start the scanning.

- When scanning is finished, the image of the card is automatically rotated so it is easily readable.



Insert the card into the scanner lengthwise.



When scanning is finished, the scanner will automatically rotate the image so it's easily readable in the Destination Application.

In this example, the Destination Application is Microsoft Paint, so the card image appears in the Paint window.



NOTE: Do not use the Card Reader to scan business cards. They can jam the Reader's mechanism. Use the Automatic Document Feeder to scan business cards.

Configuring the One Touch Buttons

Each One Touch button configuration consists of a **Destination Application**, a **Scan Configuration**, and a **Document Format**. The One Touch Properties window is where you select these three elements for a button.

To open the One Touch Properties window:



1. Click the One Touch icon. It is located in the Windows Notification Area at the bottom right corner of the screen.
2. Right-click a button on the One Touch Button Panel.

REMINDER: Remember that left-clicking a button on the One Touch Button Panel starts the scanner scanning. *Right-clicking* opens the One Touch Properties window.

The One Touch Properties window opens for that button.

Right-click on a button (for example, button 2) and the Properties window opens for that button.

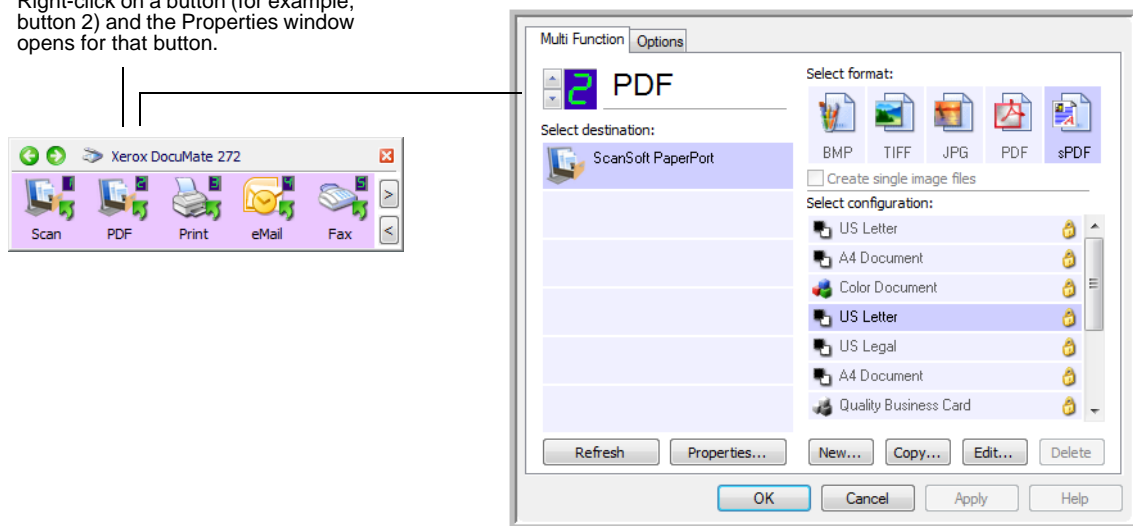

The One Touch Properties window also opens when you press, hold down, and release the Simplex or Duplex button on the scanner.

About the One Touch Properties Window

The One Touch Properties window is where you can select new settings for the buttons. The One Touch Properties window also contains special scanning features such as scanning and burn to a CD, scanning and converting text directly into an HTML web page, and scanning with optical character recognition (OCR) that turns a scanned image into text that you can edit.

NOTE: Some of the options on the One Touch Properties Window (and other One Touch windows and dialog boxes) are “grayed out” and are not available. Grayed out options are not appropriate for your Xerox DocuMate 272 scanner. For example, on the figure below, the option “Use Document Feeder” is selected and “grayed out” because the Xerox DocuMate 272 is an ADF scanner and *always* uses the document feeder, so there’s no reason for you to select it. If you use the One Touch application with other Xerox scanners, grayed out options become active, if appropriate.

The following example of the One Touch window shows the settings for Button 2. The button is set to scan with the scan configuration named Color Document then open PaperPort to display the scanned image. The Format and Page(s) option is set to scan in the PDF image format.

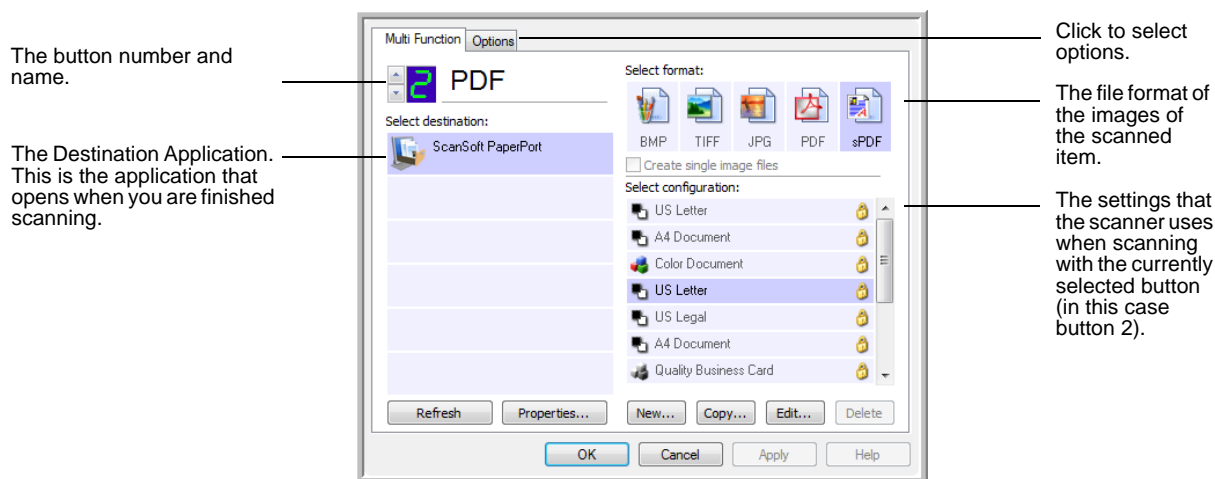

The settings on the Properties window are:

Select Destination—The list of applications that can open to display the scanned image for the selected button. To configure the list of available applications, click the Options tab at the top of the dialog box and select the desired options. See “Selecting Options for a Button” on page 48 for more information.

To make sure all of your computer’s Destination Applications are linked to One Touch 4.0, click the **Refresh** button.

NOTE: Later on, If you install new software that can be used as a Destination Application, click the **Refresh** button again to link the new software to One Touch 4.0.

Select Configuration—The list of available scan configurations for the selected button. The configuration’s basic settings include: scanning mode, resolution (dpi), page size, brightness (Br), and contrast (Cr). To see a selected scan configuration’s settings, click its icon. Click the icon again to close the detailed information.



These icons next to each scan configuration indicate the scanning mode:



NOTE: Use Configure Before Scan if you want to set the scanning mode manually before scanning. See “Configure Before Scan” on page 63.

You can also click the **Edit** button or double-click the configuration to see more detailed information about the selected configuration.

Select Format and Page(s)—A set of file formats for the scanned image for the selected button. The formats are based on the type of destination application you select. This example shows the formats that apply to the PaperPort Desktop.



The button names indicate their file types. See “Selecting Page Format Options” on page 43 for more information about the available formats.

Options tab—Displays a window for selecting options related to the selected destination application for the scanned image.

Selecting New Settings for a Button

For each of the nine One Touch buttons, you can select a new **Destination Application**, **Scan Configuration**, and **Document Format**.

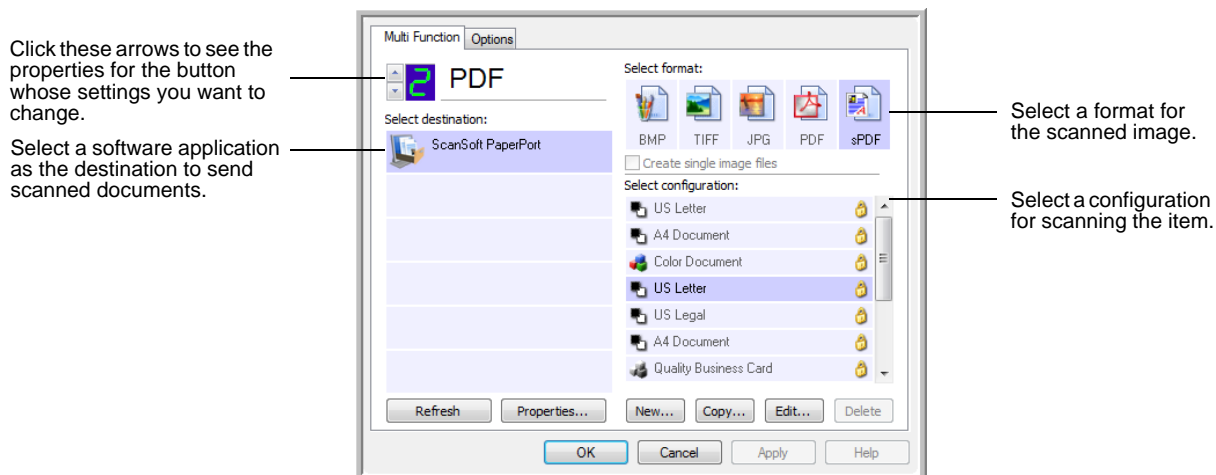

To select new settings for the Scanner Button:

1. Click the button selection arrows to select the button you want to change.

Each button has its own settings. So, as you click the arrows to cycle through the buttons, the available settings on the window change to show them for each button.

2. From the **Select Destination** list, select the application where you want documents sent when scanning is finished.

See “Selecting Options for a Button” on page 48 to display a full list of the Destination Applications that you can use with the scanner.

NOTE: If you select a word processing program such as Microsoft WordPad or Microsoft Word and a page format that can be used for OCR (such as TEXT, RTF, DOC, sPDF, or nPDF), the text in scanned images is automatically converted to word processing text. See “Scanning with Optical Character Recognition (OCR)” on page 66 for details.

3. From the **Select Configuration** list, select a scan configuration.



To scan in color, select one of the configurations indicated by the small color icon, such as the Color Document configuration.

The scan configuration list is preset for the application you select in the Select Destination list. If you select a different application, the configurations are for that application. However, you can create your own scan configurations as well.

4. Select a **Format and Page(s)** option.

The available options apply to the Destination Application you select. For example, if you select Microsoft Word as the Destination Application, the available formats are for text, such as .doc, .txt, and .rtf. However, if you select Microsoft Paint as the Destination Application, then the available formats are for graphics, such as .bmp, and .jpg.

5. Click **OK** to accept any changes and close the window.

To accept changes but keep the window open to work with other features, click **Apply**.

Note that while the One Touch Properties window is open, you cannot scan yet by clicking a button on the One Touch Panel. You must click **OK** or close the One Touch Properties window first. However, you can scan at any time by pressing the Simplex or Duplex button on the scanner.

When you are finished selecting new settings for a button and you press or click a scanner button, the document is scanned using the newly configured settings for that button.

Setting Destination Application Properties

The different types of Destination Applications have various properties that you can select.

1. On the One Touch Properties window, click a Destination Application.
2. Click the **Properties** button.

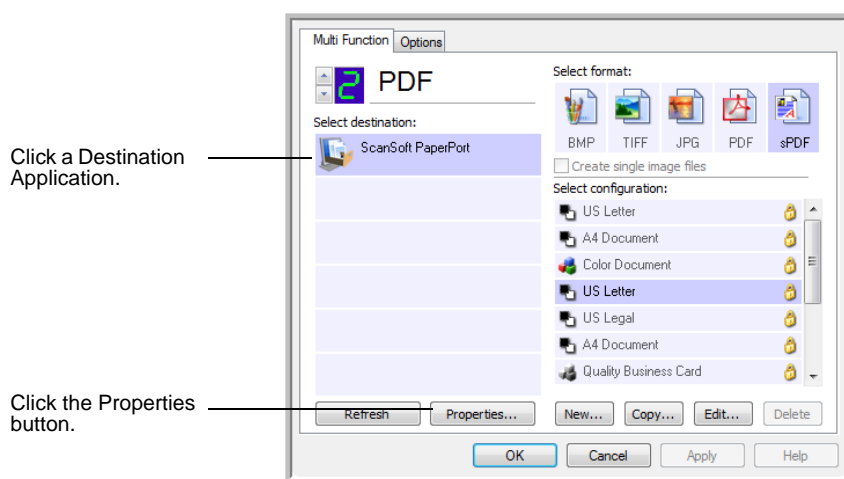

A One Touch 4.0 Link Properties dialog box opens for the type of Destination Application you selected, and the available options are for that type of application.

PaperPort Properties

These properties apply to PaperPort, and are for designating the folder to receive your scanned items.

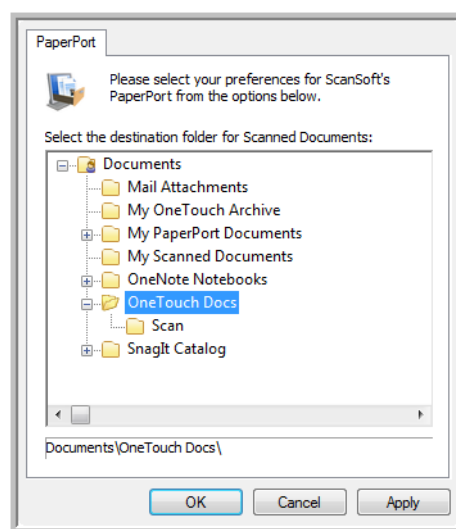

1. Select the PaperPort folder where you want the file of the scanned image to be located.
2. Click **OK**.
3. Click **OK** or **Apply** on the One Touch Properties window.

When PaperPort opens after you finish scanning, the thumbnails of your scanned documents are on the Desktop in that folder.

Text Documents Properties

These properties apply to Microsoft Word, Microsoft Excel®, and the other applications indicated by their icons in the list. The properties apply to the OCR settings for the applications.

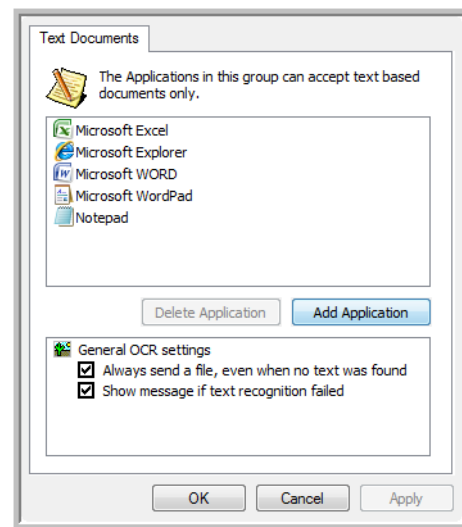

1. Click in the OCR settings boxes for the options you want.
The options will apply to all the applications in the group.

Always send a file, even when no text was found—The scanned file is sent to the OCR reader even if the image does not appear to contain text. This could occur if you scanned a photograph with a One Touch button set for text applications.

Show message if text recognition failed—A message will appear on the screen if the OCR reader does not detect text in the image.

- To add another application to the list, click the **Add Application** button.

The Add Text Based Link dialog box opens.

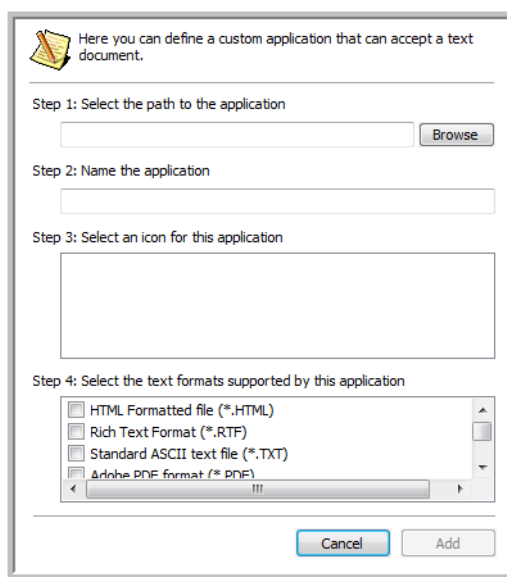

- Click **Browse** to find the application you want to add to the list.

When you select the application using the **Browse** button, steps 1, and 2 on the dialog box are automatically filled in, and the application icon appears in step 3.

- Select the icon in Step 3 of the dialog box. That is the icon that will appear in the One Touch Destination List.
- In step 4 of the dialog box, select the file formats that the application will accept.

Refer to the documentation that you received with the application to see which text formats the application accepts.

The options you select under step 4 determine the page format icons in the One Touch Properties window for that group of applications.

- Click the **Add** button.
- Click **OK** or **Apply** on the Link Properties window.
- Click **Refresh** on the One Touch Properties window.
- Click **OK** or **Apply** on the One Touch Properties window.

Image Documents Properties

These properties apply to OmniPage Pro that you received with your scanner, plus Microsoft Paint and other image processing applications.

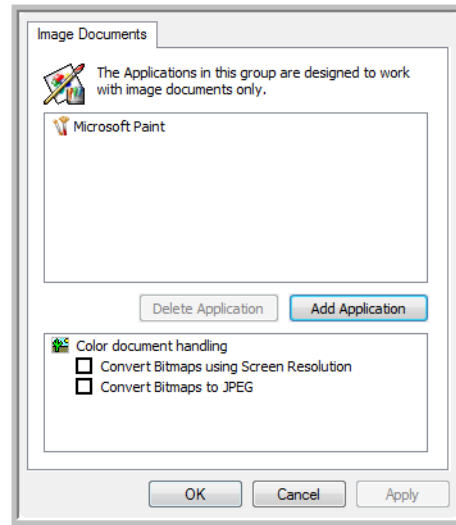

1. Click in the Color document handling settings boxes for the options you want.

The options will apply to all the applications in the group.

Convert Bitmaps using Screen Resolution—Use this option to ensure that an image will fit on the computer's screen. When a computer screen is set to a lower resolution, bitmap images with a higher resolution may be too big to fit on the screen. Converting the bitmap image to match the screen resolution ensures that the image fits on the screen.

Convert Bitmaps to JPEG—JPEG files can be compressed to produce smaller file sizes and, therefore, shorter transmission times. Use this option to provide that compression capability to image files.

2. To add another application to the list, click the **Add Application** button.
See the steps on page 39 to add an application to the list.
3. Click **OK**.
4. Click **Refresh** on the One Touch Properties window.
5. Click **OK** or **Apply** on the One Touch Properties window.

Storage Properties

These properties apply to the Destination Application named Transfer to Storage. If a CD burner is attached to your computer, you also use this dialog box to start the Burn to CD process. See the section “Scan and Burn to a CD” on page 70.

You can also set up multiple configurations to store scanned items in separate locations. See “The Storage Options Tab (Archive)” on page 57 and “Scanning to Multiple Folders” on page 58.

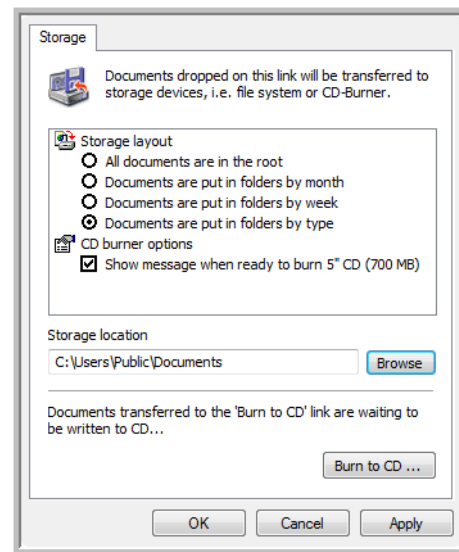

NOTE: If you do not have a CD burner attached to your computer, the CD options are not shown on the dialog box. The Burn to CD option is only available for Windows XP and Windows Vista.

1. Click the Storage Layout options you want.

All documents are in the root—The scanned documents are saved in the root of the folder specified in the Storage Location.

Documents are put into folders by month, week, or type—Folders are created based on your selection (month, week, or type) and the scanned documents are saved in those folders. New folders are created for each month and week so you can keep track of when you scanned the documents.

2. Click the **Browse** button to specify the location to store the scanned documents, or type a location directly into the box.

If you have a CD burner attached to your computer, the option **Show message when ready to burn 5" CD (700MB)**, should also be selected so you will see a message when it's time to click the **Burn to CD** button.

3. Click **OK** on the Link Properties window.

eMail Properties

These properties apply to email applications so you can specify the folder for documents that you will attach to an email message. Microsoft Outlook® will accept direct attachment of documents to a blank email message as soon as scanning is finished, but other email applications may not. If you're using one of those applications, such as America Online® (AOL), you need to know which folder contains the scanned documents so you can manually attach them to your email messages.

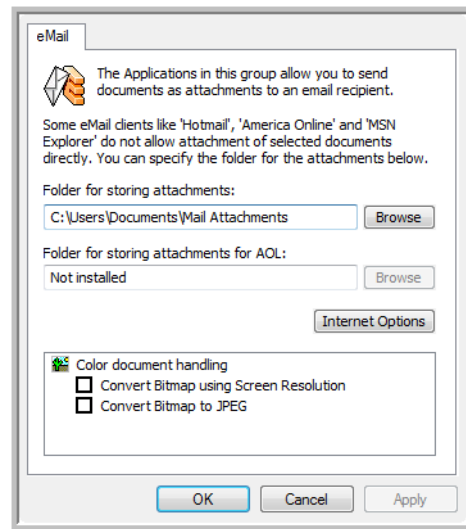

1. Click the **Browse** button for **Folder for storing attachments** and choose a folder for your eMail attachments.
2. If you are using AOL on your computer, and the folder name for AOL is incorrect, click the **Browse** button and find the correct AOL folder.

For scanned images to be auto-attached to a blank email message, you must have the specific folder location AOL uses to find the attachments. Please contact AOL for more information about the folder location in which AOL stores attachments.

3. If you need to change your email client, or any other internet options, click the **Internet Options** button.

The Windows Internet Options Control Panel opens. Click the Programs tab and choose a new email client from the Email list. These are the standard Windows Internet options. Please see your Windows documentation for more information about Internet options. If you are using AOL, please see the AOL user manual for making changes to the Internet options applicable to AOL.

4. Select the options for color document handling.

Convert Bitmaps using Screen Resolution—Use this option to ensure that an image will fit on the computer’s screen. When a computer screen is set to a lower resolution, bitmap images with a higher resolution may be too big to fit on the screen. Converting the bitmap image to match the screen resolution ensures that the image fits on the screen.

Convert Bitmaps to JPEG—JPEG files can be compressed to produce smaller file sizes and, therefore, shorter transmission times. Use this option to provide that compression capability to image files.

5. Click **OK**.
6. Click **OK** or **Apply** on the One Touch Properties window.

Selecting Page Format Options

The Page Format options that you select determines the file format of the scanned document. Appropriate page format options and file types are available for the type of Destination Application selected for the button.

The available options are for images and text.

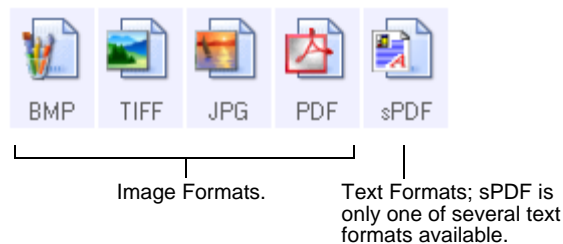

The Text Formats are for text file types. The names of the formats indicate their file types. See “Text Formats” on page 45 for details.

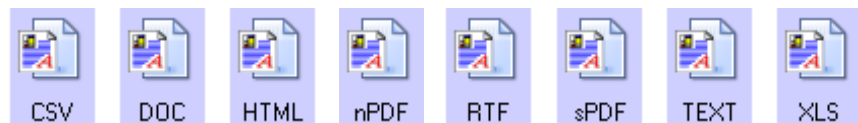

Create Single Image Files

The TIFF and PDF formats support multiple page documents. If you are scanning as a TIFF or PDF file and want one file created for each image scanned, select [Create single image files]. Note that this option is automatically selected and disabled if you have selected a format that only supports single pages, such as BMP or JPG.

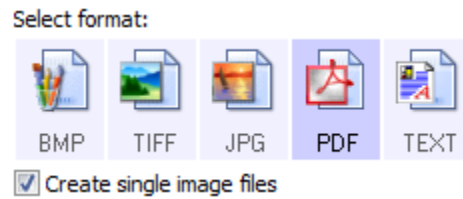

Image Formats

Select an image file format for photos, artwork or other documents that you want to save as images. BMP and TIFF are standard image file formats generally used if you want to do additional image processing, such as photo touch-up or color correction. Both of those file formats tend to be larger than the JPEG format.

Because JPEG image files can be reduced in size, the JPEG format is often used for images on web pages, or if file size might be a problem when electronically sending the files. JPEG files are reduced in size by lowering their image quality, and you can select the degree of quality for your scanned images from the JPEG page format icon.

The PDF format is often used to create images of text pages. You may want to select PDF as the page format when scanning text pages that do not require OCR processing or other processing. The PDF format is also used to put multi-page documents on web sites as pdf-readable files. As with the JPEG option, the PDF format can be reduced in size or quality.

NOTE: The two other PDF formats—nPDF and sPDF—are for scanning with OCR processing and with the ability to search the scanned text. See the next section, “Text Formats,” and also “Scanning with sPDF or nPDF and Searching for Text” on page 68 for details.

To select a JPEG or PDF file size:

1. Select **JPG** or **PDF** as the page format.
2. Right-click on the **JPG** or **PDF** icon.

A menu opens.

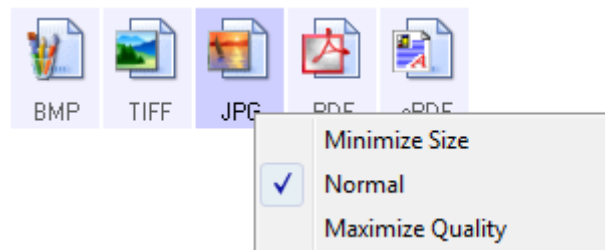

3. Choose the file size/image quality option for your scanned images.

Minimize Size—Smallest file size, lowest image quality.

Normal—Medium file size, some loss of image quality.

Maximum Quality—Largest file size, no loss of image quality.

Your selection pertains only to the button currently selected on the One Touch Properties window. Other buttons that have JPG or PDF selected as the Page Format are not affected, so you can set the JPEG or PDF file size/image quality independently for each button.

4. Click **OK** or **Apply** on the One Touch Properties window.

Text Formats

Selecting the text format option also selects OCR processing as an automatic step for scanning. Therefore, when you scan a document with the text format selected, the text portions of the document are automatically converted to editable text. See “Scanning with Optical Character Recognition (OCR)” on page 66.

Select a text format for documents with text or numbers, such as a business letter, report, or spreadsheet. The text format icon has several file formats available, depending on the Destination Application you select.

The specific file format is the file name extension on the text format icon.

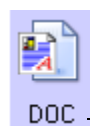

The specific text format; this example is for Microsoft Word format (.doc).

As you select Destination Applications that are text applications, the text format icon changes to match the file type of the application. In some cases, the Destination Application supports several file types, and you can right-click on the icon to choose the particular file type for that application.

To select a file type for the text format:

1. Select the Destination Application.
2. Right-click on the text format icon.

A menu opens. The following figure shows samples for different Destination Applications.

Example menu for the TEXT format when the Destination Application is Microsoft Word.

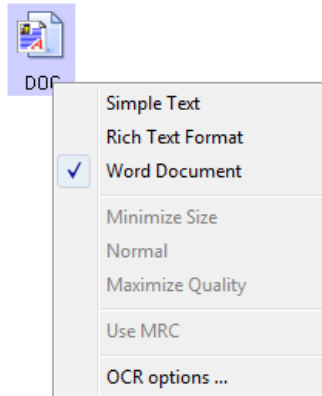

Example menu for the TEXT format when the Destination Application is PaperPort or a Storage location.

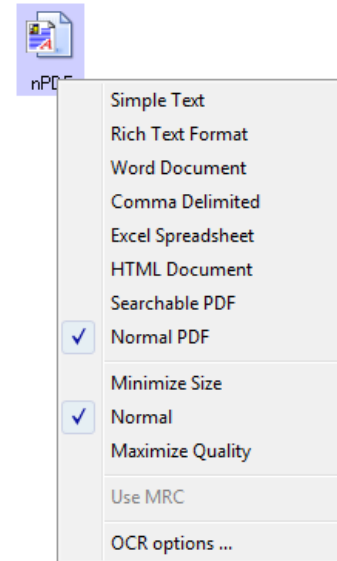

3. Choose the file type that you want for the text format.

Your selection of a file type pertains only to the button currently selected on the One Touch Properties window. Other buttons that have a text option selected as the Page Format are not affected, so you can set the text file type independently for each button.



Simple Text—The .txt file format. Text with no formatting; used by the standard Microsoft Notepad application.



Rich Text Format—The .rtf file format. Text that retains formatting when converted. Available with Microsoft Wordpad and Word.



Word Document—The .doc file format used by Microsoft Word.



Comma Delimited—The .csv file format; used for database or spreadsheet data with fields separated by commas. When the document is converted into editable text by the OCR software, the fields are maintained so you can copy and paste them to a database or spreadsheet application.



Excel Spreadsheet—The .xls file format used by Microsoft Excel.



HTML Document—The .htm file format used to create web pages.



Searchable PDF—The .sPDF file format used by Adobe Acrobat and OmniPage Pro. This format converts scanned text into PDF with text search and OCR capabilities. It is only available if you have One Touch OmniPage or the OmniPage Pro software installed on your computer. See “Scanning with sPDF or nPDF and Searching for Text” on page 68 for details.



Normal PDF—The .nPDF file format used by Adobe Acrobat and OmniPage Pro. This format converts scanned text into PDF with text search and OCR capabilities, you can edit the text in an nPDF image if a PDF editing program is installed. It is only available if the One Touch OmniPage or the OmniPage Pro software installed on your computer. See “Scanning with sPDF or nPDF and Searching for Text” on page 68 for details.

- To change the OCR settings, choose **OCR Options**.

The OCR Options provide a series of selections for the OCR feature when you scan text. This menu option is only available if you have the One Touch OmniPage Module or OmniPage Pro installed on your computer. See the **One Touch OmniPage Mini-Guide** on Disc 1 for details.

Note that the OCR Options settings apply to all buttons. If you change them for one button, those changes apply to the other buttons as well.

- Click **OK** or **Apply** on the One Touch Properties window.

Renaming a One Touch Button

The One Touch buttons have names that identify their pre-set functions, such as OCR and PDF, but you can edit the names.

To change the button names:

- Open the One Touch Properties window.
- Using the arrows, choose the button that you want to rename.
- Select the name's text and type a new name.

Click the arrows to get to the button to rename, then select the name text.

Type a new name for the button.

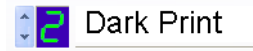

- Click **OK** or **Apply**.

The button is now renamed.

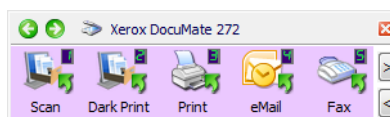

Selecting Options for a Button

The One Touch Options determine the types of Destination Applications available for a button, as well as the location of the files of your scanned items.

To select options:

1. Open the One Touch Properties window and click the **Options** tab.

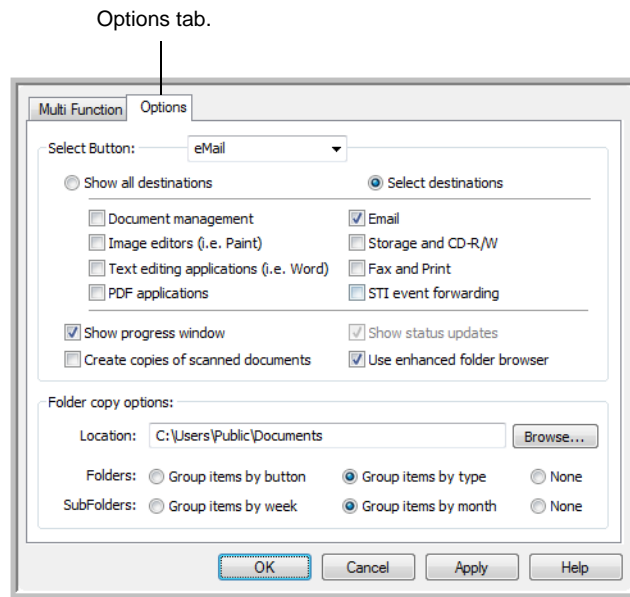

2. Click the **Select Button** menu arrow and select the button for new options.
3. Select button options as described below.

Show All Destinations—This option selects all the Destination Application categories. The list of Destination Applications available for the selected button will include all the applications on your computer that fall into these categories. This is the default selection for Button 8. The list also includes printers and other devices connected to your computer so, for example, you can scan an item and have it printed immediately.

Select Destinations—Select this option to individually choose the types of applications to include in the list of Destination Applications. Check the boxes for the type of application to include.

- **Document Management** includes PaperPort and other applications for processing and keeping track of your scanned documents.
- **Image Editors** include Microsoft Paint and other drawing and graphics applications.

- **Text Editors** include Microsoft Word and WordPad, Microsoft Excel, and other word processing and spreadsheet applications. Select this option if you want OCR processing to convert your scanned documents to text that you can edit. See “Scanning with Optical Character Recognition (OCR)” on page 66 for more about OCR.
 - **PDF applications** are for documents scanned to the PDF format.
 - **Email** includes Microsoft Outlook and other eMail applications. See “eMail Properties” on page 42 for details about attaching scanned documents to your email messages.
 - **Storage and CD-R/W** is for either storing scanned documents in a folder, or sending them to a CD burner to create a CD containing the scanned documents. See “Transferring Scanned Documents to Storage” on page 76 and “Scan and Burn to a CD” on page 70 for details.
 - **Fax and Print** is for sending your scanned documents directly to your printer or fax software for faxing.
 - **Sti event forwarding** is for using another application’s interface for scanning. The One Touch Event Forwarding dialog box opens so you can select which application to use to continue scanning. See “Scanning with Event Forwarding” on page 72 for details.
4. After selecting a new category for the Destination Applications, click the **Multi Function** tab to see which ones are added to the list.

Show Progress Window—Select this option to display the progress window of the document(s) during scanning.

Use enhanced folder browser—Select this option if you want to save your scans to a network location that is not a mapped drive on your computer.

Create copies of scanned documents—Sometimes the image of a scanned document is only saved as a temporary file until its Destination Application is finished using it. In those cases you may or may not want an additional, permanent copy saved on your hard drive.

For example, if you scan a picture to an email application, the scanned image is saved as a temporary file, then attached to the email, and the email is sent. Later, the temporary file of the scanned picture is deleted. The same situation may occur when you scan directly to a printer or scan to a fax application. After a scanned item is printed or faxed, its temporary file is deleted. However, by selecting this **Create copies of scanned documents** option, you can choose to save permanent copies of the scanned items on your hard drive.

The copies will be saved in the folder specified in the Folder Copy Options section (see the figure on page 48 and the description below).

This option is not available if either **Document Management** or **Storage and CD-R/W** are selected because, by default, file copies for those types of Destination Applications are already automatically saved in the folder for copies.

For that reason, this option is not available for the default settings of Buttons 1 and 2. Those buttons have PaperPort as their Destination Application, and PaperPort is a **Document Management** application.

Likewise, the option is not available for the default setting of Button 7, Archive, because it is set as Transfer to Storage with the Destination Application type set as **Storage and CD-R/W**.

Folder Copy Options—This section of the dialog box sets the location for copies of your scanned documents and how you want to group them.

Click the **Browse** button and find the folder for the copies. Select the grouping option for the documents. The Group by button option groups the documents under the name of the One Touch button. For example, if the button is named Printer, the documents are grouped under the name Printer. Group by type arranges the scanned documents by the type of file, such as .doc or .jpg. If you also want to group them by date you can choose the week and month options.

5. Click **OK** to save the options for the selected button.

Creating a New Scan Configuration

The scan configurations are where you select the scanning resolution, brightness, mode (color, black&white, or grayscale), and a number of other settings.

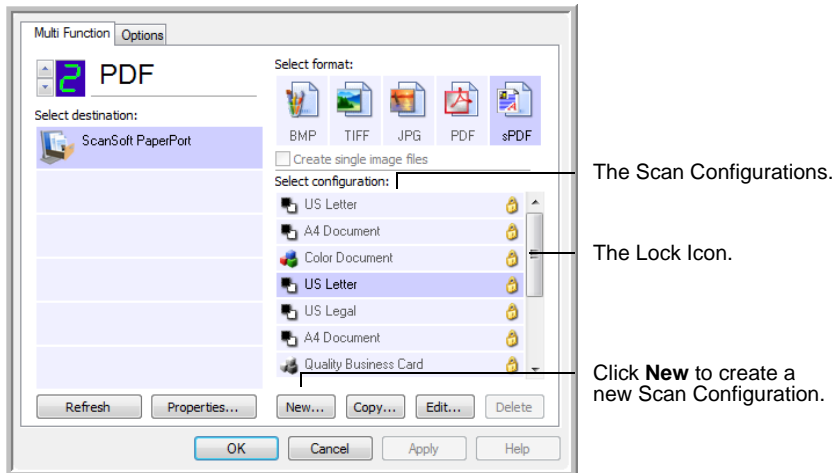

Note the lock icon on the preset configurations. Although you can unlock and edit the preset configurations, we recommend that you leave them locked, and only add new configurations. That way, you will always have the original factory-set configurations available.

To create a new configuration:

1. Open the One Touch Properties window and make sure the **Multi Function** tab is selected.
2. Scroll through the applications in the Select Destination list and click the type of application for which you want to create a new scan configuration.

When you create a new scan configuration, it will be listed for the buttons that are set for the same types of Destination Applications. For example, if you create a new configuration for a button that is set to show image editor applications, that new configuration also appears for any other buttons set for image editors, but not for buttons set for text editing applications. Thus, you can create specific sets of scan configurations for specific functions and they appear only when appropriate.

3. Click the **New** button.

If you want to start from the settings of another configuration, select the configuration, then click the **Copy** button.

If the **Scan Settings** tab is not selected, click it.

4. On the Scan Configuration Properties dialog box, type a name.

TIP: If you're going to set up the new configuration to scan duplex (two-sided), include that in the name, such as "Scan for Dark Print (Duplex)," to remind you that it is a duplex scan.

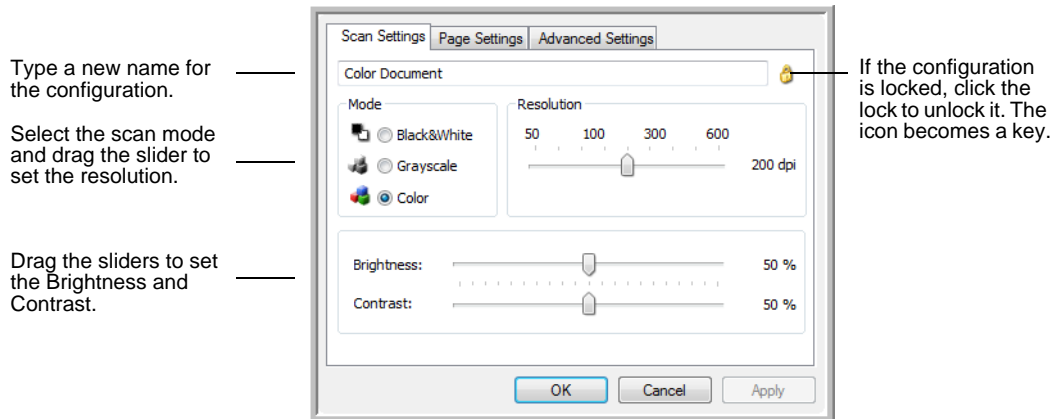

NOTE: If you select a printer or other device in the Select Destinations list, the dialog box may have an additional Device Settings tab for setting specific options for the particular device.

5. Select scan settings for the new scan configuration.

Mode—Select a scanning mode:

- **Black&White** to scan in black and white. For example, letters and memos are usually scanned in black and white. This scan mode produces the smallest file size.
- **GrayScale** to scan items such as documents containing drawings or black and white photographs. The scanning produces an image of up to 256 shades of gray.
- **Color** to scan color photographs and other color items. Color scans have the largest file size.

Resolution—Drag the slider to the right or left to adjust the dots per inch (dpi) of the resolution. The maximum resolution is 600 dpi; the minimum is 50 dpi. The higher the dpi setting, the sharper and clearer the scanned image. However, higher dpi settings take longer to scan and produce larger files for the scanned images.

Brightness and Contrast—Sometimes an item is scanned with the brightness and contrast set too light or too dark. For example, a note written with a light pencil may need to be scanned darker to improve legibility.

Brightness refers to the lightness or darkness of the image. Contrast is the range between the darkest and lightest portions of the image. The greater the contrast, the more difference between the lighter and darker shades in the image.

Drag the sliders to the right or left to adjust the brightness and contrast of the scanned image. The Contrast setting does not apply to the Black&White mode.

6. If you want to lock the configuration, click the key icon to change it from a key to a lock.
7. Click the **Page Settings** tab to select page settings.

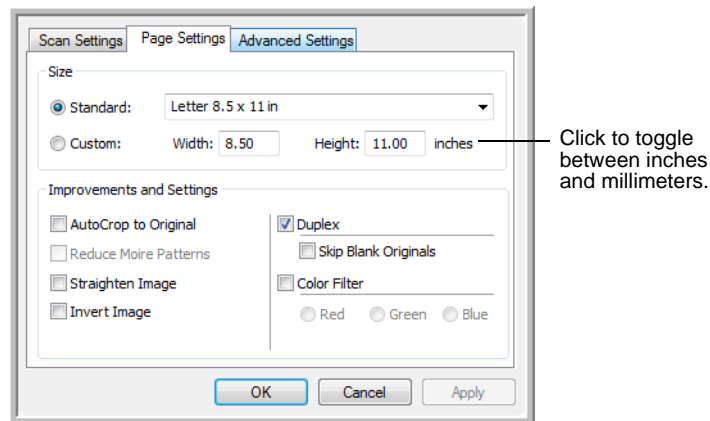

Size—Click **Standard**, click the menu arrow and choose a page size from the list, or click **Custom** and enter the horizontal and vertical page dimensions in the boxes. The maximum size is 8.5" x 14". The units of measurement can be inches or millimeters. Click the name of the units, inches or millimeters, to toggle between them.

Improvements and Settings—Only the options that apply to the selected Destination Application are available.

- **AutoCrop to Original**—Select this option to let the scanner automatically determine the size of the item being scanned. For example, if you scan a 5" x 7" photo, the scanner will determine the size of the photo.

When using the AutoCrop to Original option, always use the paper guides on the scanner so the page is not skewed. Skewed pages may not crop properly.

For single-sided scans, the scan area is the size of the image. For double-sided scans, the scan area is the size of the larger of the two areas on the front and back of the page.

- **Reduce Moire Patterns**—Moire patterns are wavy, rippled lines that sometimes appear on the scanned images of photographs or illustrations, particularly newspaper and magazine illustrations. Selecting **Reduce Moire Patterns** will limit or eliminate moire patterns in the scanned image. This option is only available for the GrayScale or Color Mode at 300dpi or less.

- **Straighten Image**—Select this option to let the scanner automatically determine if a page is skewed, then straighten its image. The scanner detects page edges and can sense when the page is fed through at an angle. However, if the page is fed through at too great an angle, the image may not straighten correctly. In that case, re-scan the page using the paper guides to feed the paper in straight.
- **Invert Image**—Only available for Black&White Mode, this option reverses the black and whites of an image.

Original Image.

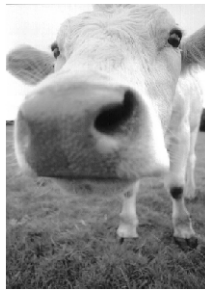

Inverted Image.



- **Duplex**—Scan both sides of the page. If this option is not selected, the scanner will scan the front side of the page only.

NOTE: The Simplex and Duplex buttons on the scanner take precedence over the One Touch settings. In other words, if the LED number on the scanner is configured to scan as Duplex, but you press the Simplex button, the scanner scans in Simplex, and vice versa.

- **Skip Blank Originals**—Skips pages that are completely blank. Typically you use this option when you will scan a stack of two-sided pages which have a number of blank sides. This option is only available for Duplex scanning in Black&White Mode.

- **Color Filter**—Color filter is the ability of your scanner to automatically remove a color from a scanned item. For example, if you are scanning a letter with a red watermark, you can choose to filter out the red so the scanned letter just shows the text and not the red watermark. Color filter applies to Black&White or Grayscale Mode.

The original with a red watermark over black text.

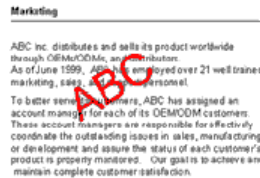

The scanned item with the red filtered out.

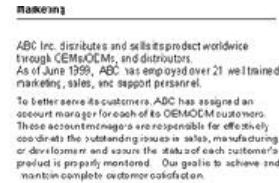

8. Click the **Advanced Settings** tab.

The options of the Advanced Settings tab are for the Color or Grayscale scanning mode.

Saturation is the strength or purity of a color, hue is the color your eyes see as reflected from the image, and gamma controls the brightness of the midtones of the color.

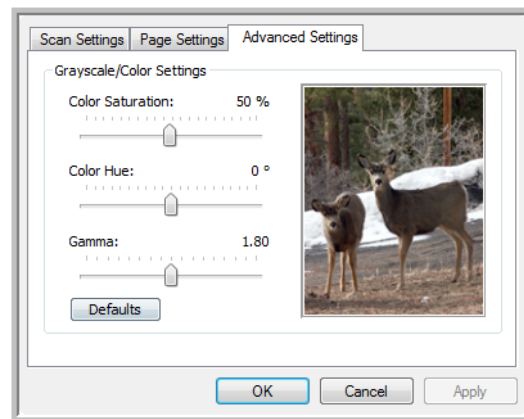

9. Drag the sliders to the left and right to change the color settings. As you do, the image changes to show the effects of the new settings.
10. Click **OK** to save the new configuration.

It will now appear in the list of Scan Configurations on the One Touch Properties window for the appropriate Destination Applications.

The Device Settings Tab

A Device Settings tab appears on the Scan Configurations dialog box when your selected Destination Application sends the scanned image to a printer, fax application, or other device. You use the options on the Device Settings tab to select settings for the device.

1. Click on the **Device Settings** tab.

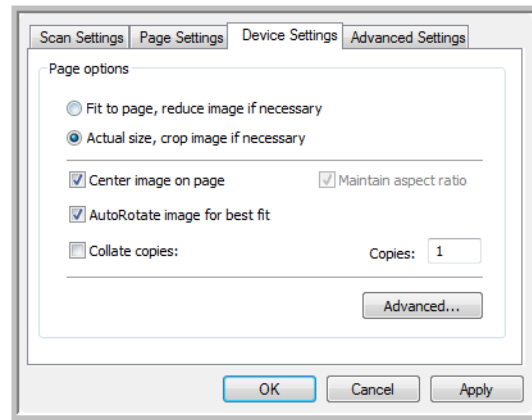

Fit to page, reduce image if necessary—If the scanned image is too big to be printed or faxed on a single page, the image will automatically be reduced to fit the page.

Actual size, crop image if necessary—If the scanned image is too big to be printed or faxed on a single page, the image will automatically be cropped around its edges to fit on the page.

Center image on page—The image will be printed in the center of the page instead of at the top right corner.

Maintain aspect ratio—The aspect ratio is the length-to-width relationship of the image's dimensions. Select this option so the image's relative proportions remain constant.

AutoRotate image for best fit—If the image is a Landscape format and the device is printing in the Portrait mode, or vice versa, rotate the image to fit on the page.

Collate copies—If you are printing more than one page, collate the copies. Enter the number of copies in the **Copies** box.

Advanced—Click to see additional settings for the device. The dialog that opens is specific to the device. For example, if the device is your printer, the dialog box is your printer's setup settings.

2. Click **OK** or **Apply**.

The Storage Options Tab (Archive)

A Storage Options tab is on the Scan Configurations dialog box when the selected Destination Application is set as Transfer to Storage. You use the options on this tab to select where you want to save your scanned items for storage when scanning with that particular Scan Configuration. Button 7 is set as the default Archive button for scanning to storage, with Transfer to Storage as the destination. So if you want to have the Scan Configuration apply to Button 7, switch to it first before creating the new Scan Configuration.

NOTE: The selections you make using the Storage Options tab override the storage options that apply to the Storage Properties. This means that you can create separate Scan Configurations to store scanned items at various locations in addition to the main location set by the Storage Properties. See “Storage Properties” on page 41 and “Transferring Scanned Documents to Storage” on page 76 for more details.

1. Click on the **Storage Options** tab.

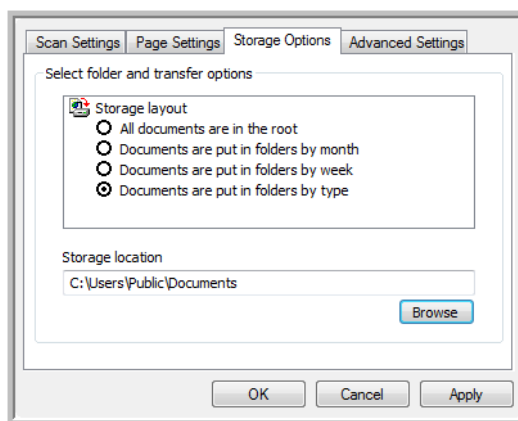

2. Click the Storage Layout options you want.

All documents are in the root—The scanned documents are saved in the root of the folder specified in the Storage Location.

Documents are put into folders by month, week, or type—Folders are created based on your selection (month, week, or type) and the scanned documents are saved in those folders. New folders are created for each month and week so you can keep track of when you scanned the documents.

By default, the location of the archived documents is at **C:\Documents and Settings\<your user name>\My Documents\My OneTouch Archive** and then in a folder based on your selection for the Storage Location. For example, if the file type is TIFF, and you select **Documents are put into**

folders by type, the default location of scanned archive documents is at **C:\Documents and Settings\<your user name>\My Documents\My OneTouch Archive\TIFF Documents**.

3. Click the **Browse** button to specify the location to store the scanned documents, or type a location directly into the box.
4. Click **OK** or **Apply**.

Scanning to Multiple Folders

When archiving documents with the Transfer to Storage option, you can scan them to multiple folders. For example, one folder might be for “Business Receipts,” a second folder might be for “Personal Receipts,” and a third folder might be for “Annual Receipts.”

To scan to multiple folders, you create multiple scan configurations with Transfer to Storage as the Destination Application, and assign each scan configuration to one of the scanner buttons.

Setting up multiple folders for transfer to storage:

1. Using Microsoft Windows, create the folders that you want to use for storing scanned items. Note that you can also create the folders later while creating the new scan configurations.
2. Open the One Touch Properties window.
3. Select **Transfer to Storage** as the Destination Application.
4. Click the **New** button.

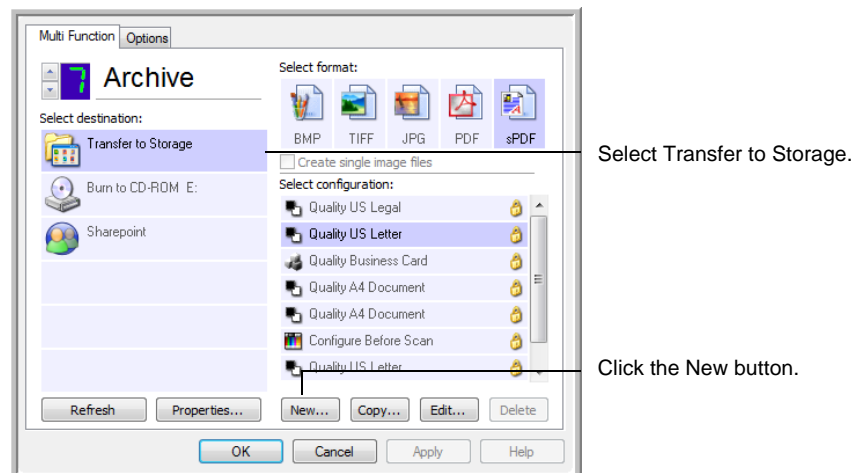

The Scan Configuration Properties dialog box opens.

5. To help you remember which folder it is, give the new configuration a name that indicates the folder name, such as “Storage for Business Receipts.”

6. Click the **Scan Settings**, **Page Settings**, and **Advanced Settings** tabs, and select the settings you want.
7. Click the **Storage Options** tab.

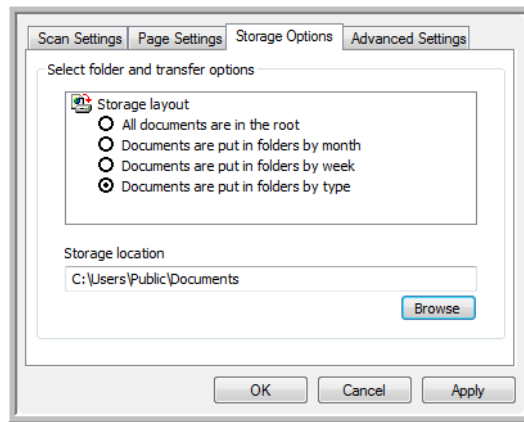

8. Click the **Browse** button.
9. Select the folder you created for storing the scanned documents.

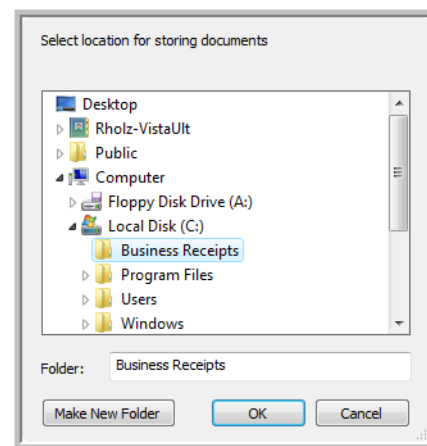

If you haven't created the folder yet, you can click the **Make New Folder** button and type the name for the new folder.

- Click **OK**. The selected folder will now be set as the Storage Location, such as “Business Receipts.”

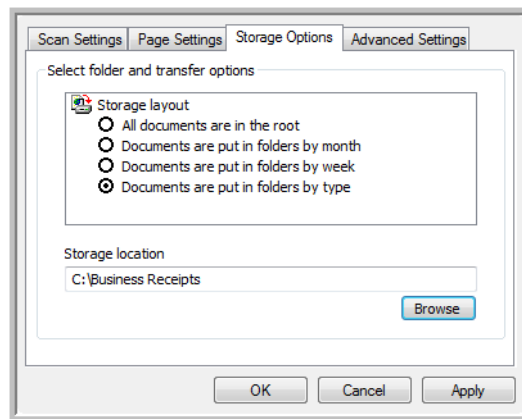

- Click **Apply**. The new configuration is now listed as a Transfer to Storage configuration.
- Repeat the process to create additional new configurations, such as one named “Storage for Personal Receipts.”
- Make sure to designate separate folders as the Storage Locations for the new configurations.

You will now have multiple configurations set up for the Transfer to Storage destination, and each configuration scans documents to separate folders.

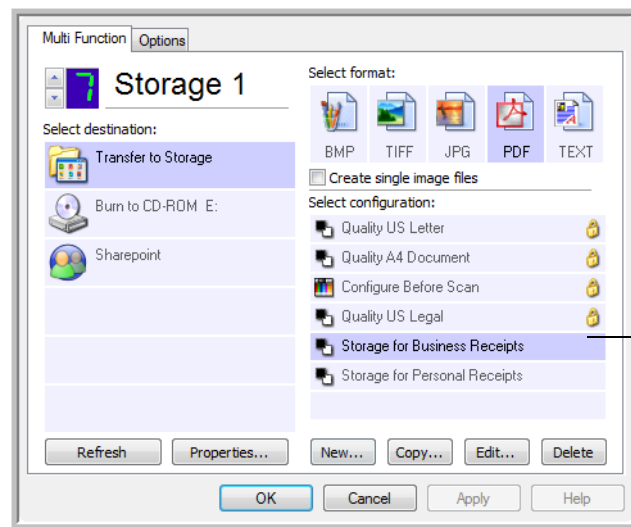

The new configurations apply to the Transfer to Storage Destination Application.

14. Now click the arrow buttons to select a scanner button for each new configuration. Click **Apply** to set that button for that configuration.

The following examples show that buttons 7 and 8 have been set to scan to each of the new configurations.

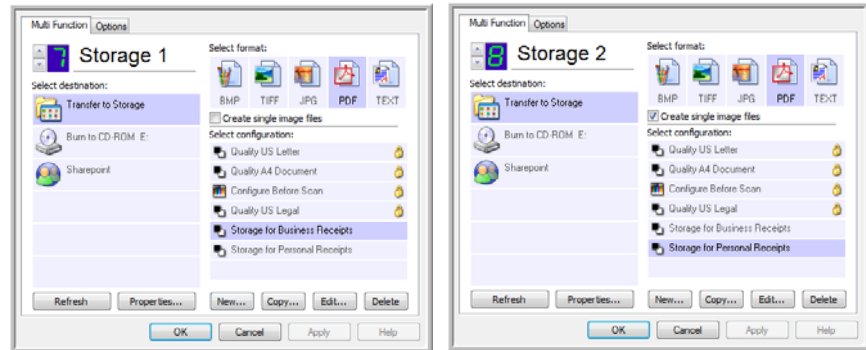

Note that the button names have also been changed to Storage 1 and Storage 2 to remind you that both send documents to storage, but to different locations. To change button names, see “Renaming a One Touch Button” on page 47.

Scan to multiple storage folders:

1. Insert the documents you want to scan to storage.
2. Press the **Destination Selector** buttons on the scanner to get to one of the buttons set up for scanning to storage.
3. Press the **Simplex** or **Duplex** button to scan the documents.
4. When scanning is finished, insert the next set of documents and press the **Destination Selector** buttons to get to the next button you have set up for scanning.
5. Press the **Simplex** or **Duplex** button to scan the documents.

When scanning is finished, the two sets of documents are stored in two separate folders.

Editing or Deleting Scan Configurations

NOTE: Your scanner comes with a number of configurations pre-set at the factory. To ensure that your scanner will always have a set of correct scan configurations, do not delete the preset configurations. We also recommend that you keep those configurations locked so they are not inadvertently deleted. That way, you will always have the factory-settings available. If you do edit or delete them, and want to get the factory pre-sets back again, you will need to uninstall then re-install your scanner.

To edit or delete a scan configuration:

1. Open the One Touch Properties window.
2. Select the scan configuration you want to edit or delete.

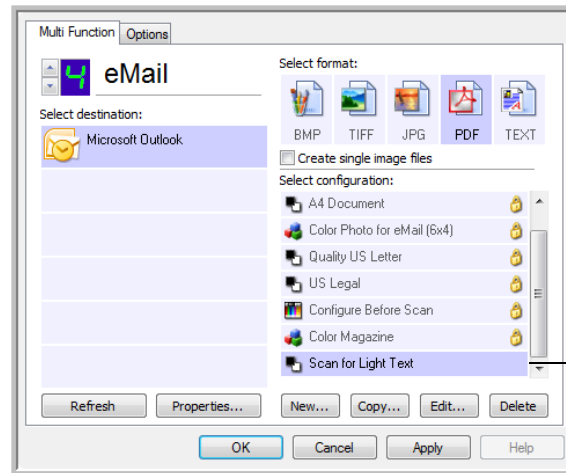

Select the scan configuration to edit or delete. It must be unlocked, as indicated by not having a lock displayed here.

3. To delete the configuration, click the **Delete** button.
4. To edit the configuration, click the **Edit** button.

The Scan Configuration Properties dialog box opens for that configuration.

You can make changes to a configuration, but for the changes to be saved, the configuration must first be unlocked. Click the Lock icon to unlock the configuration. Clicking it toggles between locking and unlocking the configuration. The key icon indicates the configuration is unlocked.

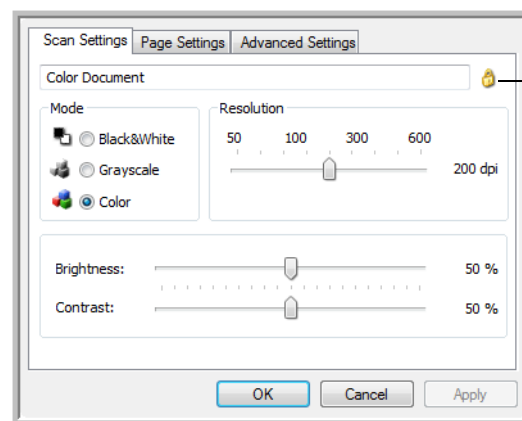

Click the Lock/Key icon to toggle between locked and unlocked.

5. Edit the settings and click **OK**.
6. Click **OK** to close the dialog box.

Configure Before Scan

Choosing Configure Before Scan simply opens a scanning interface when you press or click a scan button. You can then use the interface to change the Resolution, Scan Mode, and other settings. When you scan, the scanned image will still be sent as the file type and to the same Destination Application already selected in the OneTouch Properties window for that button.

To Set Configure Before Scan:

1. Open the One Touch Properties window.
2. Using the arrows, choose the button that you want to set to configure before scanning.
3. Select the scan configuration **Configure Before Scan**.

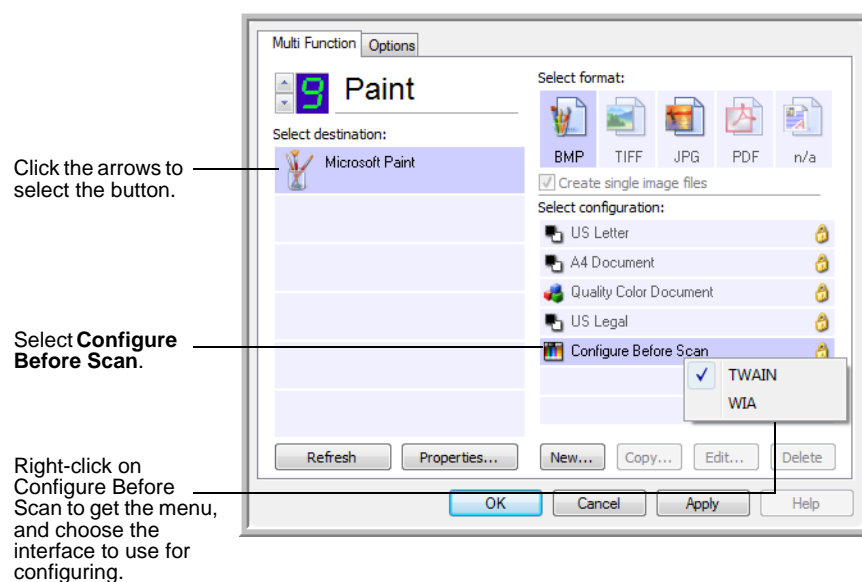

4. Right-click on **Configure Before Scan** and choose an interface to use for configuring before scanning.

TWAIN—The TWAIN Interface opens for you to make changes prior to scanning. See “Accessing the TWAIN Interface from PaperPort” on page 82.

WIA—The Windows Image Acquisition Interface (WIA) opens for you to make changes prior to scanning (available for Windows XP or Windows Vista only). See “Scanning with the WIA Interface” on page 98.

5. Click **OK** or **Apply** on the One Touch Properties window.

To Scan Using Configure Before Scan

1. Put the documents in the scanner's ADF tray or on the flatbed glass.
2. Click on the button you set to use the **Configure Before Scan** option.

In the example shown on the previous page, the scanning option 9 has been set to use Configure Before Scan.

3. The TWAIN interface will open.

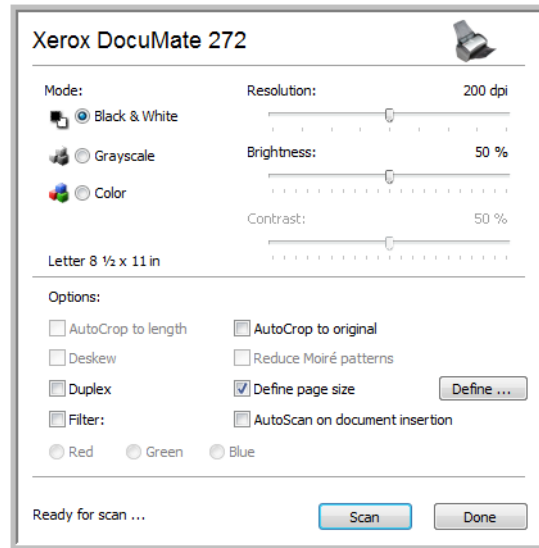

4. Choose the Options applicable to your scan batch.
5. Click on the Scan button in the TWAIN interface.
6. Your documents will be scanned and sent to the Destination Application specified in the One Touch 4.0 Properties.

In the example shown on the previous page, the Destination Application is Microsoft Paint.

The TWAIN interface lists the scanning options available with your Xerox DocuMate 272 scanner. Please see “Scanning with the TWAIN Interface from PaperPort” on page 81.

Canceling a Configure Before Scan

To cancel a scan after scanning has begun:

1. Click on the **Cancel** button in the scanning progress window.

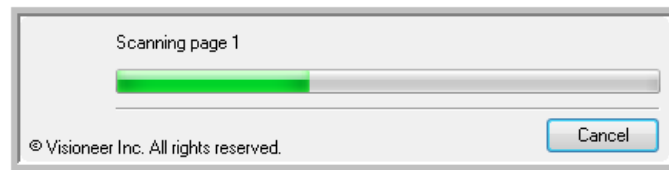

2. The following window will open asking you if you want to cancel the entire job.

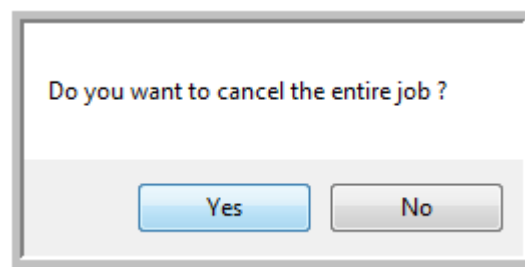

- **Yes**—scanning stops and all pages scanned in this batch, up to this point, will be deleted. The TWAIN interface will close and you can restart your scan from the beginning.

Choose **Yes** if the TWAIN scan settings are incorrect for your current scanning batch.

For instance, the Scan Mode is Black & White but you want to scan your documents in color, choose Yes to delete any scanned pages, then select the correct Picture Type and restart the scanning.

- **No**—scanning stops, but all pages scanned in this batch, up to this point, are not deleted and the TWAIN interface remains open. You can place a new page in the ADF, adjust the TWAIN settings for the new page, then click on the Scan button in the TWAIN interface to continue scanning. At the end of the scanning batch, all pages from the first portion of the scan and second will be sent to the Destination Application.

Choose this option if, for instance, you have been scanning a black & white document but you want to insert a color page into the document. Instead of having to re-scan the entire stack, you can stop the current scan, change the Picture Type from Black & White to Color, then restart the scanning without losing the pages already scanned.

Scanning with Optical Character Recognition (OCR)

Optical Character Recognition (OCR) is like a printer in reverse. Instead of printing what's on the screen onto paper, OCR converts text and numbers on a scanned page into editable text and numbers. You can then work with the text and numbers to edit, spellcheck, change font or type size, sort, calculate, and so forth.

NOTE: For all OCR processing, use the original factory settings for OCR scanning that came with your scanner. When scanning with other settings, use at least 300 dpi for the resolution. If the original documents are of poor quality and have small type, 400 dpi can be used as the maximum resolution.

The One Touch OmniPage Module or the OmniPage Pro software must be installed on your computer in order to use the OCR options with the One Touch 4.0 software and your DocuMate 272 scanner. One Touch 4.0 and OmniPage Pro work together to combine scanning with OCR processing into one integrated step. The One Touch OmniPage Module was automatically installed when you installed your driver, the OmniPage Pro software is on the Disc 2 CD that you received with your scanner. The One Touch OmniPage Module and the OmniPage Software can both be installed on your computer at the same time, however, the features in the One Touch OmniPage Module will take precedence over the OmniPage software features when using One Touch 4.0. The "One Touch OmniPage Mini-Guide" is available on the Disc 1 installation CD.

With the One Touch OmniPage Module or OmniPage Pro software installed, the OCR process is automatic when the page format on the One Touch Properties window is a text format, such as DOC, TEXT, XLS, RTF, and so forth.

NOTE: If you have uninstalled the One Touch OmniPage Module or the OmniPage Pro software from your computer, items scanned as a text format are still converted with the OCR process, however, the options available with the process are then limited.

To scan with OCR:

1. To scan using the buttons on the scanner, press the Destination Selector until the LED is at 6, then press the **Simplex** or **Duplex** button.

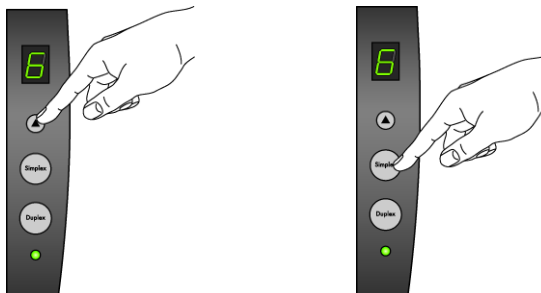

NOTE: One Touch Button 6 is preset as your OCR button. But you can also set up any other button to scan and OCR the text.



2. To scan from the One Touch Button Panel, click the One Touch icon in the Windows Notification Area, click the arrows to see Button 6, then click Button 6.

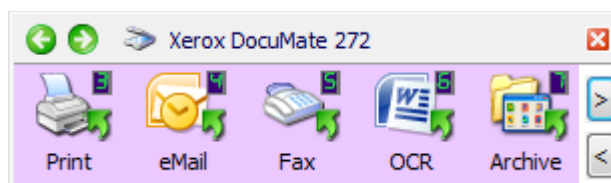

Click the arrows until Button 6 is on the panel, then click Button 6.

Your scanned pages appear in the Destination Application with their text ready for editing and other text processing.

NOTE: OCR scanning is also for spreadsheets so you can work in Microsoft Excel (or other spreadsheet application) with the figures and text from the original spreadsheets.

NOTE: Please Refer to the **One Touch OmniPage Mini-Guide**, on Disc 1 that you received with your scanner, for detailed instructions on configuring and scanning with the advanced OCR Options.

Scanning with sPDF or nPDF and Searching for Text

Searchable PDF (sPDF) and Normal PDF (nPDF) are special forms of an Adobe PDF file. sPDF converts scanned text into the PDF format with text search and OCR capabilities. nPDF has those same features, plus you can edit the text in an nPDF image if you have a PDF editing program. The two PDF formats can also produce images with different image quality, so you may want to experiment with them to determine which is better for your scanned documents. sPDF and nPDF are only available as page format options if you have the One Touch OmniPage module or the OmniPage Pro software installed on your computer.

To scan with sPDF or nPDF:

1. Open the One Touch Properties window.
2. Using the arrows, choose a One Touch button to use for the sPDF or nPDF scanning.
3. Select a Destination Application that uses a text format as the page format.
4. Right-click on the text format icon.

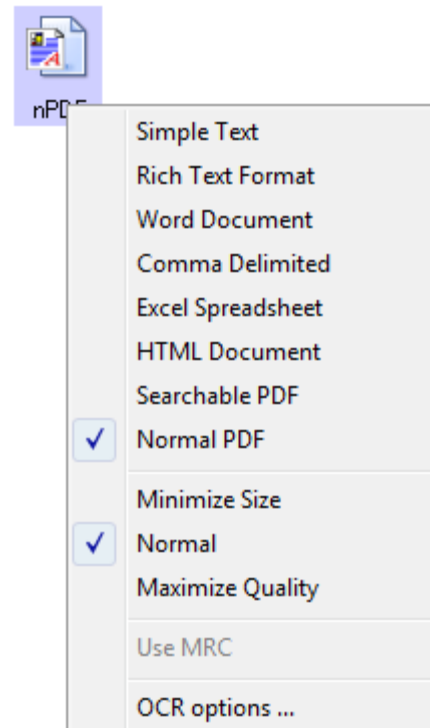

5. Choose the **Searchable PDF** or **Normal PDF** option for the page format.

NOTE: Not all Destination Applications have the sPDF and nPDF options. Microsoft Word, for example, does not have them as scanning options.

The settings for the button (button 8 in this example) now show your page format selection.

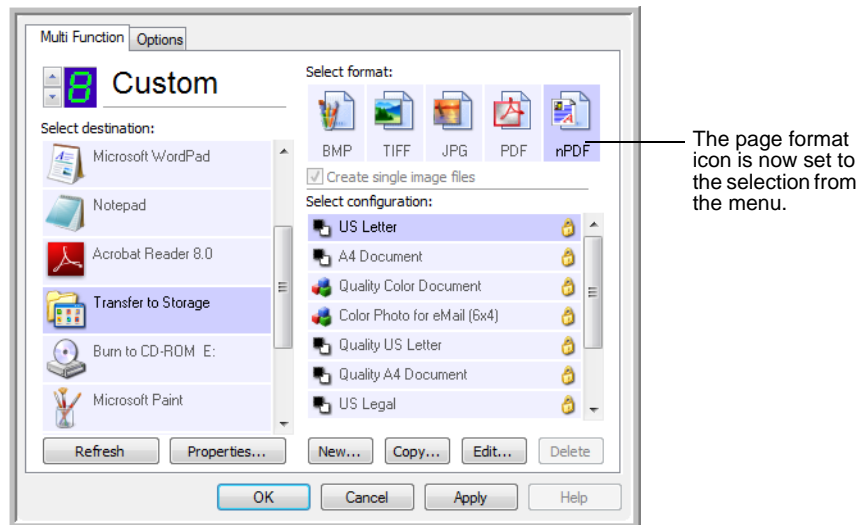

6. Choose a Scan Configuration.
7. Click **OK**. The One Touch Properties window closes.
8. Now scan with that button and the scanned document will be in the sPDF or nPDF format that was selected for the button.

NOTE: The Transfer to Storage selection for a Destination Application also has the sPDF and nPDF options. That means you can scan and store items directly to a server in these formats.

9. To search for the text, open Adobe Acrobat Reader or Adobe Acrobat.
10. From the Adobe Acrobat **File** menu choose **Open**, and open the file you just scanned.
11. From the Adobe Acrobat **Edit** menu choose **Find**.
The Find dialog box opens.
12. Enter the text you want to find, and click the **Find** button.

See the Adobe Acrobat user manual for more about finding text in a PDF file, or about editing PDF text.

Scan and Burn to a CD

If you have a CD burner attached to your computer, you can scan directly from your Xerox DocuMate 272 scanner onto a CD. This feature is available only on computers running Windows XP or Windows Vista.

To scan and burn to a CD:

1. Put a blank CD into your computer's CD Drive.
2. Open the One Touch Properties window.
3. Using the arrows, choose a button to use for scanning and burning to a CD.
4. Select **Burn to CD** as the Destination Application.

The Burn to CD Destination Application is only available if you have a CD burner attached to your computer, but you do not need to have a CD in the burner to select the destination.

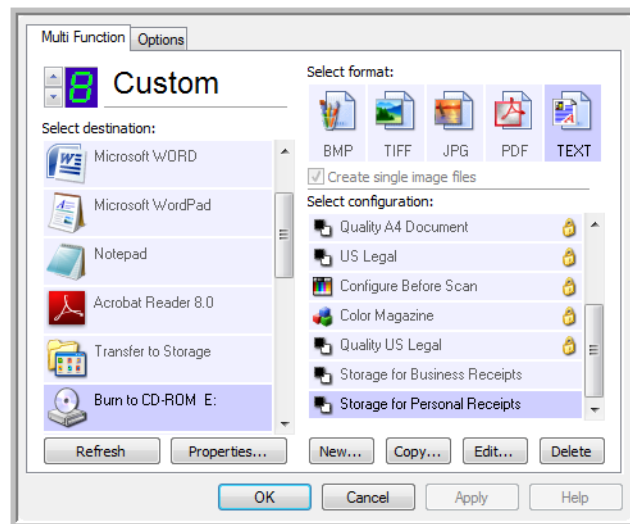

5. Choose a Page Format and a Scan Configuration.
 6. Click **OK**.
- The One Touch Properties window closes.
7. Now start scanning using the button you selected to use to scan and burn to CD.

When scanning is finished, a bubble message on the screen tells you that files are waiting to be burned to the CD.

8. Open the One Touch window and make sure that the **Burn to CD** Destination Application is still selected and click the **Properties** button.

The One Touch 4.0 Link Properties window opens.

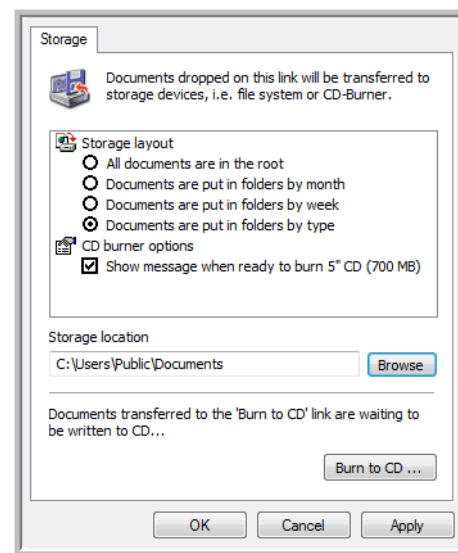

9. Make sure a blank CD is in the CD burner.
10. Click the **Burn to CD** button. The CD burner begins and your scanned documents are written to the CD.

NOTE: Until you click **Burn to CD** these files are stored in your computer at **C:\Documents and Settings\\Local Settings\Application Data\Microsoft\CD Burning**. This is where Windows XP and Windows Vista store all files waiting to be burned to a CD by the automatic CD writing wizard. If other files are also waiting in this location, they will get written with the OneTouch files on the CD.

NOTE: When scanning items to burn to a CD, you should always use one of the factory-set default configurations, or a custom configuration specifically set up for CD burning. The default configurations are already set up to send the scanned images to the proper storage location where the Windows XP and Windows Vista CD writing wizard can find the files to burn to the CD. Likewise, when you create a custom configuration for CD burning, the OneTouch software will automatically make sure the storage location is correct.

To create a custom configuration for CD burning, select **Burn to CD** as the Destination Application, then click the **New** button and create the new configuration. You won't need to select a storage location because it will be correctly preset for you by the OneTouch software.

Note however, that if you have created other custom configurations with different storage locations (for example, see "Scanning to Multiple Folders" on page 58), do not use them for the Burn to CD Destination Application. Otherwise, the Windows XP and Windows Vista CD writing wizard will not be able to find the images to burn onto the CD.

Scanning with Event Forwarding

If you want to specify an application to use for scanning at the start of the process, you can use event forwarding. The scanner will feed in the first page, but will then stop until you select the application to use. After you select the application, its interface will open and you can use it to continue with the scanning.

To scan with event forwarding:

1. Open the One Touch Properties window.
2. Using the arrows, choose a button to use for the event forwarding.
3. Select **Still Image Client** as the Destination Application.

Note that you cannot choose a page format for this option because the actual destination application is not selected until after the scanner feeds in the first page of your document.

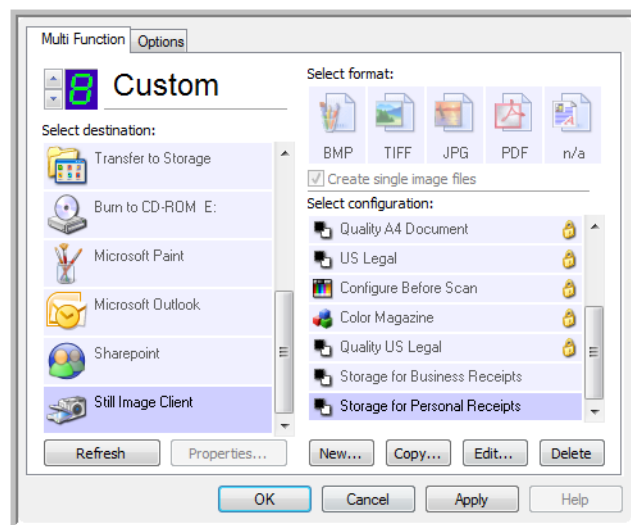

4. Choose a Scan Configuration.
5. Click **OK**.

The One Touch Properties window closes.

6. Start scanning using the button you selected for event forwarding.

A dialog box opens for you to select the application to use for scanning.

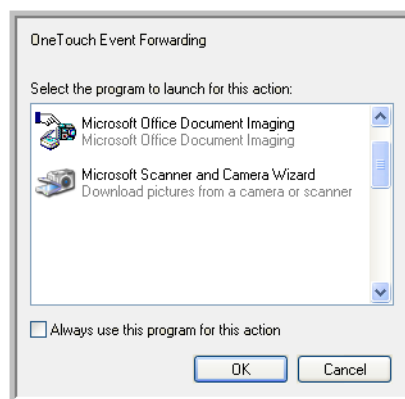

7. Select the application in the box and click **OK**.

Now the application you selected opens and you can continue the scanning from that application's TWAIN interface.

Creating an HTML Web Page from Your Scanned Documents

If you scan a document, whether a single page or multiple pages, you can have the pages converted directly to HTML formatted pages for posting directly to your web site. Those pages are then viewable by visitors to your web site without the need for any internet plug-ins or other special processing. This is, essentially, from your scanner to a web-ready format in one automatic step.

To scan and create an HTML web page:

1. Open the One Touch Properties window.
2. Using the arrows, choose Button 8, or any other button that has Microsoft Explorer as one of its Destination Applications.
3. Select **Microsoft Explorer** as the Destination Application.
4. Choose **HTML** as the Page Format.

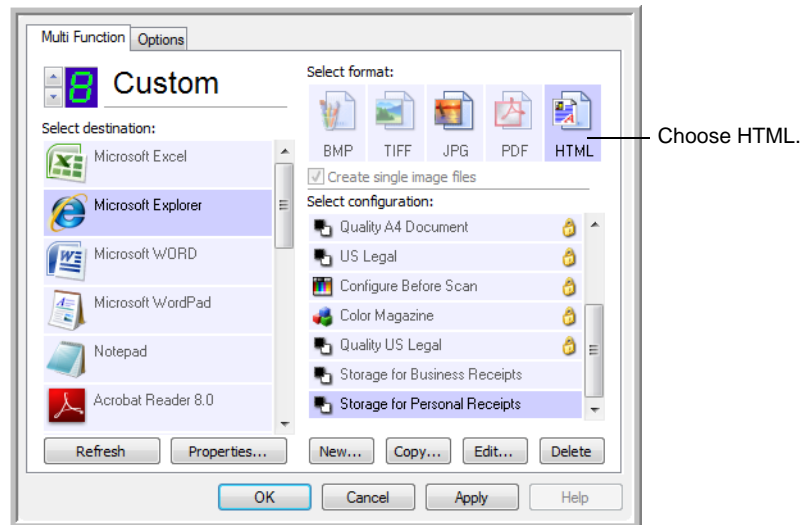

5. Choose a Scan Configuration that has the settings for the image on the HTML page.

For example, if you want the image to be in color on the HTML page, choose a color configuration.

6. Click **OK**.

The One Touch Properties window closes.

7. Now on the One Touch Button Panel, click Button 8 (or if you used another button, click it).

When scanning is finished, the document is first converted to editable text using the OCR process, then is converted into an HTML format. Microsoft Internet Explorer then opens showing your converted page.

NOTE: Depending on the complexity of the document, its conversion to the HTML format may take a few moments.

NOTE: If you have OmniPage Pro installed on your computer, you may see a thumbnail of the page. Click on the thumbnail to see the full page.

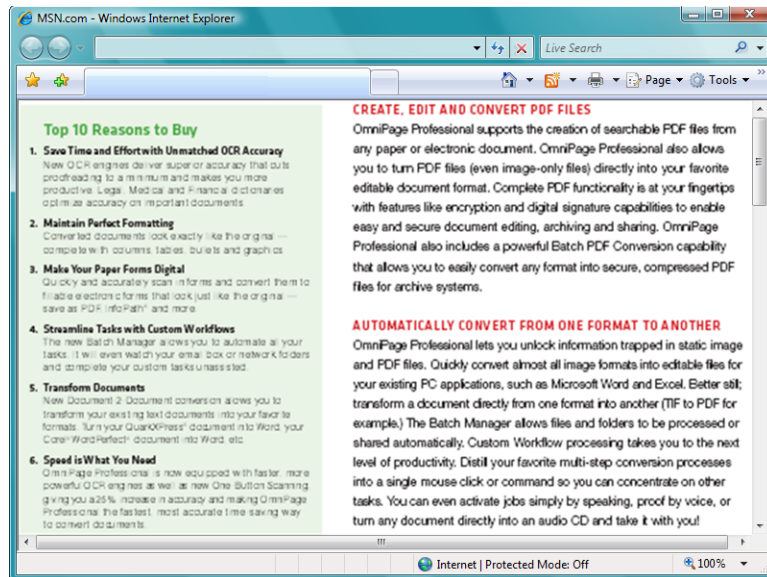

8. Choose **Save As** from the Internet Explorer **File** menu, give the page a name, and save it in the location you use for your web page files.

You may also want to write down the address shown in the Address bar to make sure you'll know where to find your new HTML page later on.

9. You can now use Microsoft Internet Explorer or other application to post the document to your web page as you would any other HTML page.

Transferring Scanned Documents to Storage

With the Transfer to Storage scanning process, you can scan documents and save them in a folder in one step. The process is ideal for archiving documents without having to manually save or process them in any other way. If you choose a text format for the file format, the documents are also automatically converted by the OCR process into editable text and numbers before being stored.

NOTE: One Touch Button 7 is preset as your Archive button. But you can also set up any other button to scan to Archive the text.

1. To scan using the buttons on the scanner, press the Destination Selector until the LED is at 7, then press the **Simplex** or **Duplex** button.
2. To scan from the One Touch Button Panel, click the One Touch icon in the Windows Notification Area, click the arrows to see Button 7, then click Button 7.

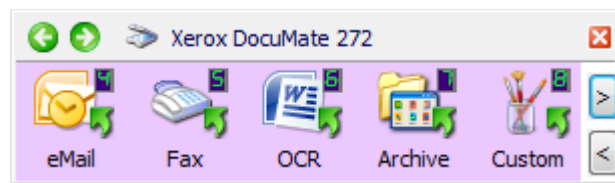

Click the arrows until Button 7 is on the panel, then click Button 7.

Your scanned pages are stored in the location that you specified on the One Touch 4.0 Link Properties window.

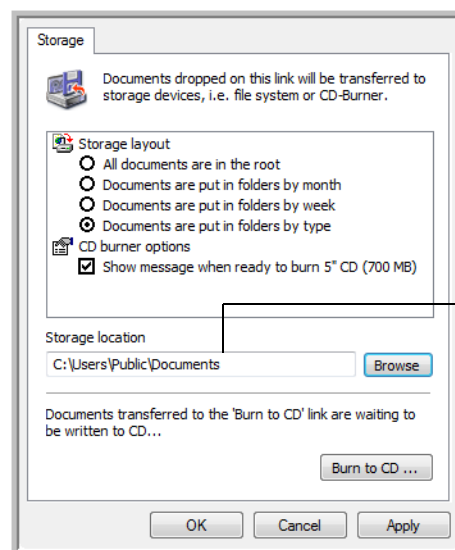

Your scanned documents will be stored at this location.

To Transfer Documents to a Server or Mapped Drive

When selecting the storage location for scanned documents, you can select a local folder, or a folder on a server or mapped drive. You select a mapped drive using the **Browse** button. See “The Storage Options Tab (Archive)” on page 57 for more information about storage options.

1. On either the One Touch 4.0 Link Properties window, or from the Scan Configuration Properties window, click the **Browse** button.

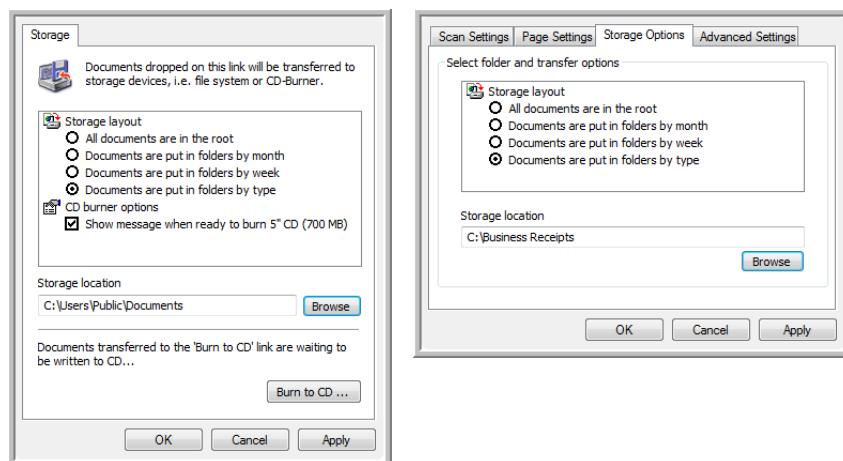

The Browse For Folder window opens.

2. Select a storage location on the mapped drive or server for the scanned documents.

Servers and mapped drives are represented by an icon that indicates its network connection.

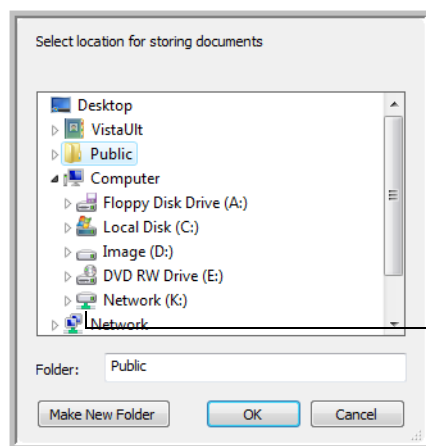

Select a mapped drive or server as indicated by the icon.

3. Click **OK**.

Now when you scan using Transfer to Storage as the Destination Application, the documents are stored on the server or mapped drive.

To Use OCR Before Transferring to Storage

If the documents you want to transfer to storage are text documents or spreadsheets, you can have them converted by the OCR process prior to being stored.

1. Open the One Touch Properties window.
2. Using the arrows, choose Button 7, or any other button if it is set up with Transfer to Storage as one of its Destination Applications.
3. Choose a text format as the file format.
4. Right-click on the text format icon and choose the file format for the scanned documents.

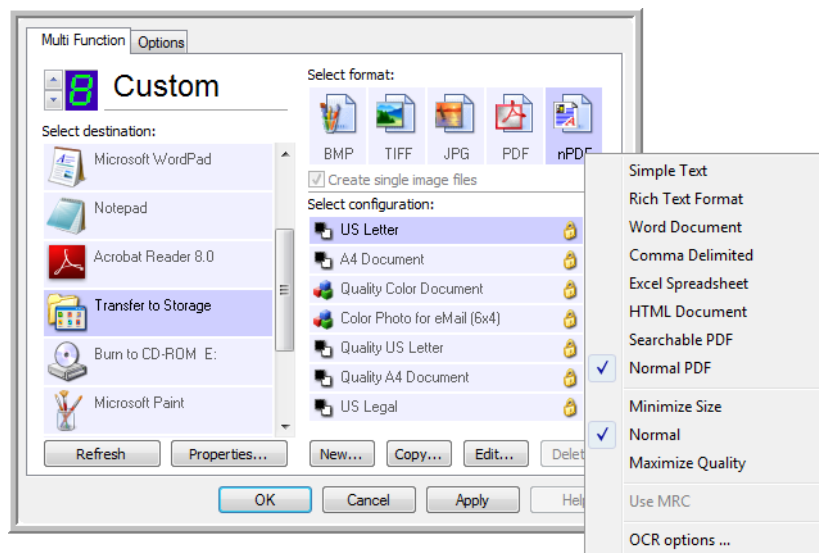

5. Choose a Scan Configuration.

6. Click **OK**.

The One Touch Properties window closes.

7. Now start scanning using Button 7 (or other button you set up for archiving).

When scanning is finished, the documents are saved in the text file format and in the location you specified.

Checking the Hardware and Setting the Lamp Power Saving

1. Right-click on the One Touch icon and choose **Show Hardware** from the pop-up menu.

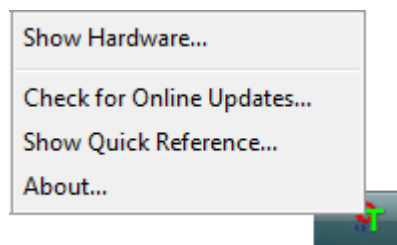

You can also click the scanner icon at the top of the One Touch Button Panel.

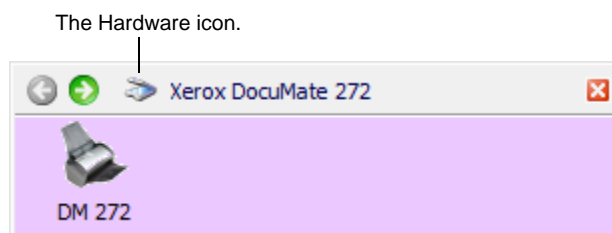

If the Hardware View of the panel is open you can also right-click on the DM272 icon.

The Hardware Properties dialog box opens and shows information about your Xerox DocuMate 272 scanner.

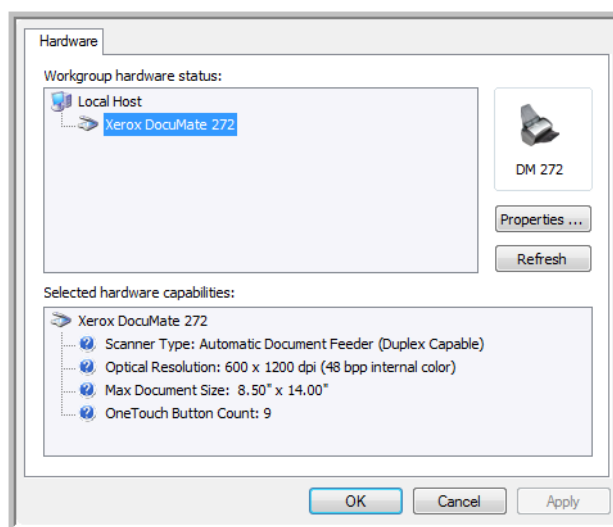

2. Click the **Properties** button.

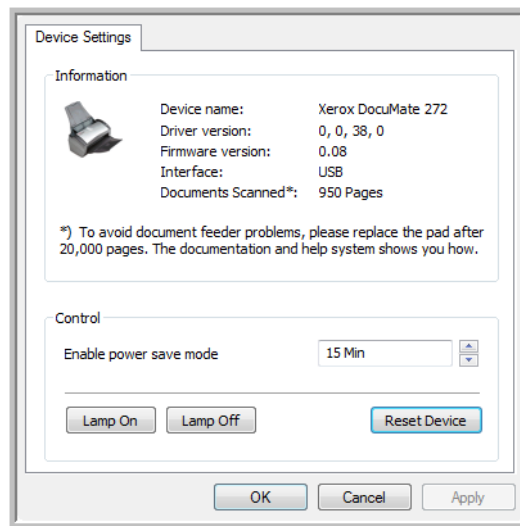

Your scanner has a built-in power saving feature that is set to power down after 15 minutes of idle time. You can change the time before the scanner powers down, from 1 minute to a maximum of 10 hours.

3. Click the arrows for the Lamp timeout setting and choose a time setting.

To turn the lamp on and off manually without turning off power to the scanner, click the **Lamp On** or **Lamp Off** buttons.

To return the scanner to its factory settings, click **Reset Device**.

4. Click **OK** to save the changes and close the dialog box.

Scanning with the TWAIN Interface from PaperPort

Instead of using the scanner buttons or the One Touch Button Panel to scan, you can also scan from the TWAIN interface. The PaperPort application that you received with your scanner provides access to the TWAIN interface. This scanning method is particularly helpful when you're already using PaperPort to file and save scanned items, or if you want to adjust scan settings prior to scanning.

A Note About Your Scanner and the TWAIN standard: TWAIN is a widely recognized procedure that software applications use to receive images from scanners, digital cameras, and other digital devices. The PaperPort software that you received with your scanner uses the TWAIN standard, and this guide shows how to scan with it. But you can also open the same TWAIN interface from many other graphics and imaging applications and scan from them as well. Because the TWAIN interface is the same regardless of the software you use to open it, you can still use the instructions in this *User's Guide* for scanning with your Xerox DocuMate 272 scanner. To access the TWAIN interface from other software, please refer to their user's guides, then return to this *User's Guide* for the steps to scan. The instructions for scanning are in the section "Scanning with the TWAIN Interface" on page 85.

NOTE: You can also access the TWAIN interface when you're scanning from the One Touch software. If the One Touch configuration you're using to scan is set to **Configure Before Scan**, and the selected option is **TWAIN**, the TWAIN interface opens right away without opening PaperPort or any other TWAIN-compliant software first. See the section "Configure Before Scan" on page 63 for details.

Accessing the TWAIN Interface from PaperPort

The instructions in this section are for accessing the TWAIN interface from the PaperPort application.

To access the TWAIN interface from PaperPort:

1. On the Windows taskbar, click **Start**, point to **Programs**, point to **PaperPort**, then click **PaperPort**.

The PaperPort desktop opens.

Scan icon.

Folders pane.

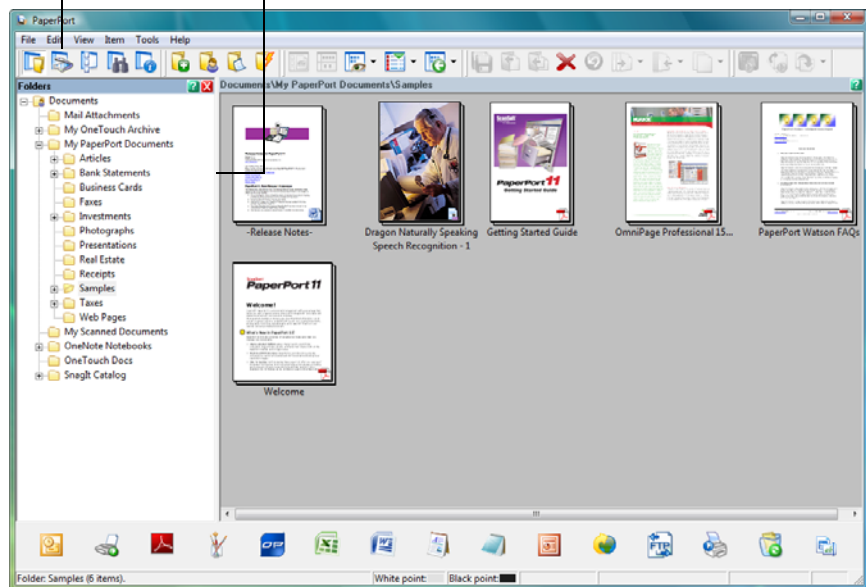

2. Click the **Scan** icon on the PaperPort command bar.

The Folders pane (which shows folders for organizing your scanned images) is replaced by the Scan pane.

Scan pane.

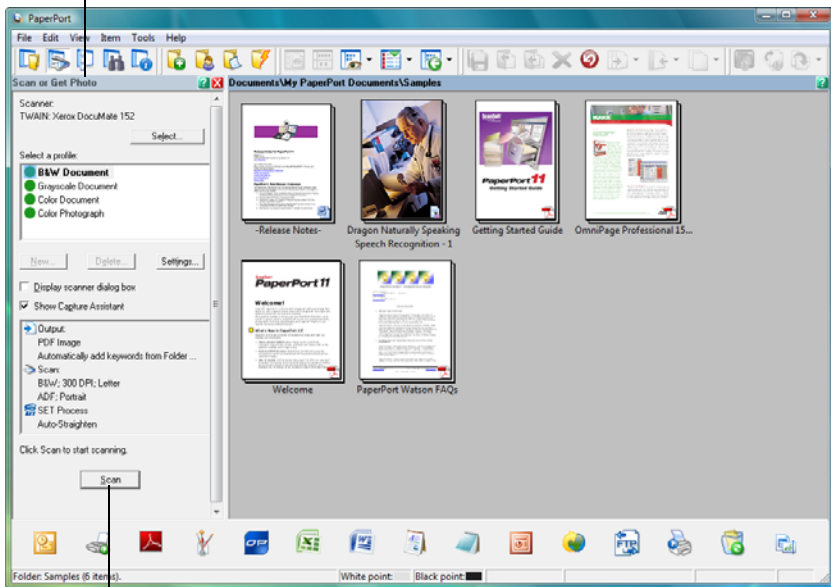

If this Scan button is not active, see the section on page 93 to set up PaperPort for the TWAIN scanning option.

NOTE: If the Scan button at the bottom of panel is not available when you make a selection from the Scanner drop-down list, PaperPort needs to be set up to use the scanner. See the section, “Setting Up PaperPort to Work With Your Scanner” on page 93.

3. Click the Scanner drop-down arrow, and select **TWAIN: Xerox DocuMate 272** from the drop-down list.

NOTE: Please wait a few moments for your selection from the drop-down list to become active. This delay only occurs the first time you select from the list while PaperPort initializes the scanner. Later on, selecting from the list happens right away.

4. In the “Scan what?” section, choose to scan a **Document** or **Photograph**.

If you want to change the format of the scanned item’s file name or file type before you start scanning, click **Settings**. The default file type for documents is .pdf and the default for photographs is .jpg. The default name of the scanned image is the day, date, and number of scanned items that day. For example, the second item scanned on a day is followed by a (2), the third by a (3) and so on. See the *PaperPort User’s Guide* for more information about the PaperPort Settings.

5. When scanning documents, use the **Create single page items** check box as follows:
 - When the check box is selected, all pages in the Automatic Document Feeder are scanned, the TWAIN interface closes, and each page is placed on the PaperPort Desktop as an individual file.
 - When the check box is not selected, the scanned pages are not placed on the PaperPort desktop until you indicate the scanning job is finished by clicking **Done** on TWAIN interface then clicking **Done** on the **PaperPort-Scan** window. Multiple pages are “stacked” on the PaperPort desktop. Note that items scanned as .jpg files cannot be stacked on the desktop. Please see the *PaperPort User’s Guide* for more information about stacks.
6. The option **Blank page is job separator** is for when you load several separate scanning jobs into the Automatic Document Feeder at the same time. Insert a blank page between them and each job will become a separate stack on the PaperPort Desktop when scanning is finished.

Please see the *PaperPort User’s Guide* for more information about this option.

7. Make sure the option **Display scanner dialog box** is selected. If this option is not selected, the TWAIN interface will not open when you click the **Scan** button. Instead, the items are scanned with the basic PaperPort settings. Documents are scanned in Black and White in the .pdf file format, and Photographs are scanned in Color in the .jpg file format.

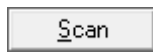

8. Click the **Scan** button on the Scan pane.

The TWAIN interface opens and you are now ready to scan from it.

Getting Help with the PaperPort Software

The PaperPort software includes a complete set of help topics that answer questions about each feature of the software. To open the Help Topics window, press the **F1** key or choose **PaperPort Help** from the **Help** menu.

You can also refer to the *PaperPort Getting Started Guide* and *PaperPort User’s Guide* on the **Disc 1** Installation CD.

Scanning with the TWAIN Interface

The TWAIN interface lists the scanning options available with your Xerox DocuMate 272 scanner.

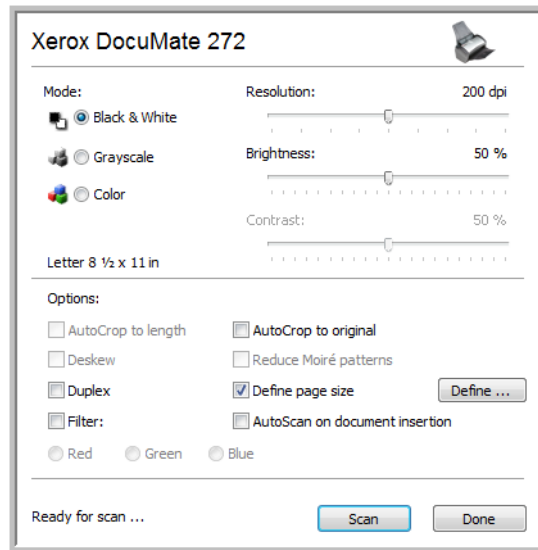

The options on the TWAIN interface are:

- **Mode**—Select a scanning mode:

Black&White to scan in black and white. The scanning pixels are all the same size and are either black or white. Use this setting for letters, memos, and other black and white material. This scan mode produces the smallest file size.

GreyScale to scan items such as documents containing drawings or black and white photographs. The scanning produces an image of up to 256 shades of gray. You can also scan a color document to turn its colors into gray shades. The file size is about one third that of a color scan.

Color to scan magazine articles, photographs, and other color images in full color. Color scans have the largest file size.

- **Resolution**—Drag the slider to the right or left to adjust the dots per inch (dpi) of the resolution. The maximum resolution is 600 dpi; the minimum is 50 dpi. This option determines the amount of detail you can see in the scanned image. The higher the dpi setting, the sharper and clearer the scanned image. However, higher dpi settings take longer to scan and produce larger files for the scanned images. Usually the higher resolution settings are used for precision work, such as photographs or fine artwork.

- **Brightness and Contrast**—Sometimes an image is scanned with the brightness and contrast set too light or too dark. For example, a note written with a light pencil may need to be scanned darker to improve legibility. Increasing or decreasing the brightness makes the scanned image lighter or darker. Contrast refers to the difference between the lighter and darker portions of the image. Increasing the contrast emphasizes the difference between the lighter and darker portions, decreasing the contrast de-emphasizes that difference. Contrast is used in conjunction with brightness.
- **AutoCrop to Original**—Select this option to let the scanner automatically determine the size of the item being scanned. For example, if you scan a 5" x 7" photo, the scanner will determine the size of the photo, and the scan area is the size of that photo.

When using the AutoCrop to Original option, always use the paper guides on the scanner so the page is not skewed.

- **Duplex**—Scan both sides of the page. If this option is not selected, the scanner will only scan the side of the page facing down when you insert it into the scanner.
- **Filter**—The Filter is the ability of your scanner to automatically remove a color from a scanned item. For example, if you are scanning a letter with a red watermark, you can choose to filter out the red so the scanned letter just shows the text and not the red watermark. The Filter option applies to Black&White or Greyscale Mode.

The original with a red watermark over black text.

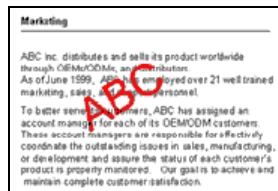

The scanned item with the red filtered out.

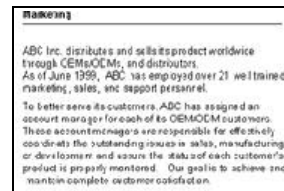

- **Reduce Moire Patterns**—Moire patterns are wavy, rippled lines that sometimes appear on the scanned images of photographs or illustrations, particularly newspaper and magazine illustrations. Selecting **Reduce Moire Patterns** will limit or eliminate moire patterns in the scanned image. This option is only available for the Greyscale or Color Mode at 300dpi or less.

- **Define page size**—Click this option to activate the **Define** button. Then click the **Define** button to see the **Define page size** dialog box for selecting a specific page size.

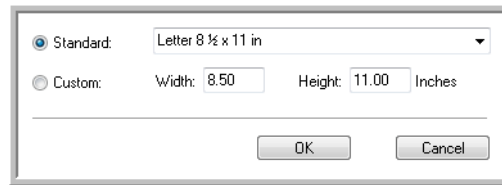

Click **Standard**, click the menu arrow and choose a page size from the list, or click **Custom** and enter the horizontal and vertical page dimensions in the boxes. The maximum size is 8.5" x 14". The units of measurement can be inches or millimeters. Click the name of the units, inches or mm (millimeters), to toggle between them.

Click **OK**.

The currently selected page size appears in the middle of the TWAIN interface on the left hand side.

The Define page size option cannot be used with **AutoCrop to original**.

- **AutoScan on document insertion**—Your Xerox DocuMate 272 scanner includes AutoLaunch technology that senses when an item is inserted into the paper feed and starts scanning immediately. Select this option to turn on the AutoLaunch feature. The item is scanned with the current settings on the TWAIN interface. If this option is not selected, the scanner waits for you to click the **Scan** button.

To scan from the TWAIN interface:

1. Select the options you want from the TWAIN interface, then load the documents with their tops into the Automatic Document Feeder. To scan a single side, insert the documents face down. To scan both sides, either side can be face up.



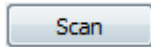

2. If the AutoScan feature is turned on, scanning begins.
If the AutoScan feature is not turned on, click the **Scan** button.

The scanner starts scanning and a progress box shows the image.

If you're using PaperPort to scan and its **Create single page items** check box is selected, all pages in the Automatic Document Feeder are scanned, the TWAIN interface closes, and each page is placed on the PaperPort Desktop as an individual file.

If PaperPort's **Create single page items** check box is not selected, the scanned pages are not placed on the PaperPort desktop until you indicate the scanning job is finished by clicking **Done** on the TWAIN interface then clicking **Done** on the **PaperPort-Scan** window.

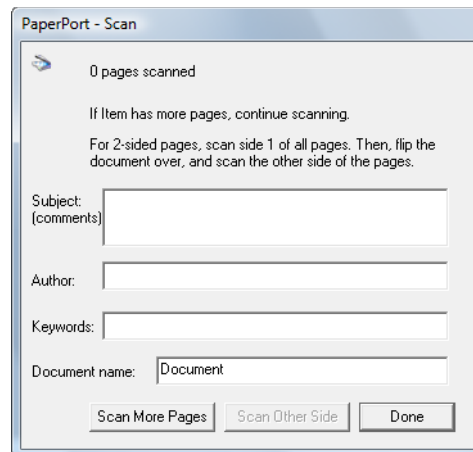

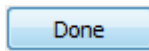

3. If you are scanning multiple pages, click the **Done** button on the TWAIN interface, and if you are using PaperPort click **Done** on the **PaperPort-Scan** window.

If you are scanning a single page, the TWAIN interface closes automatically.

When scanning is complete, the scanned images appear in the TWAIN software. This example shows a thumbnail image of a scanned page on the PaperPort Desktop.

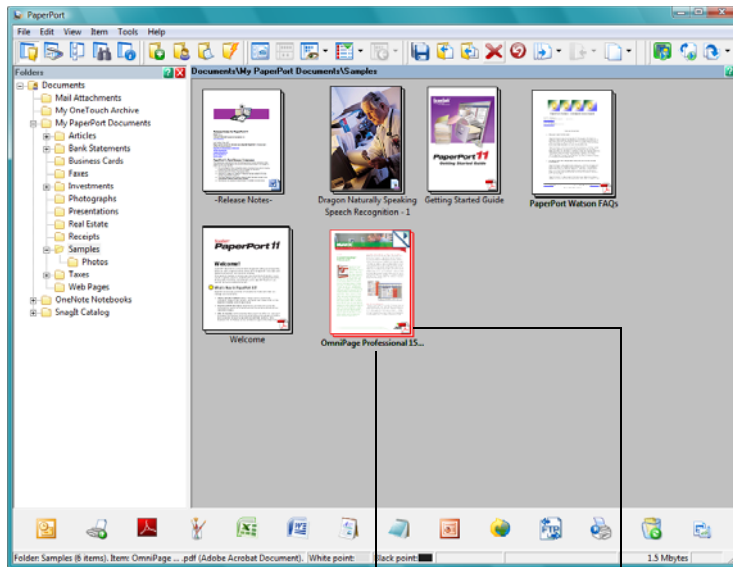

A thumbnail image of the scanned item appears on the PaperPort desktop.

The small icon represents the file format, in this case the .pdf format.

Scanning Plastic Cards from the TWAIN Interface

You can use the TWAIN interface to scan identification cards and credit cards with your scanner's Card Reader.

NOTE: If paper is in the Automatic Document Feeder, the card reader will not scan a card. The document feeder must be empty when scanning cards.

1. Open the scanning software that you use for accessing the TWAIN interface.

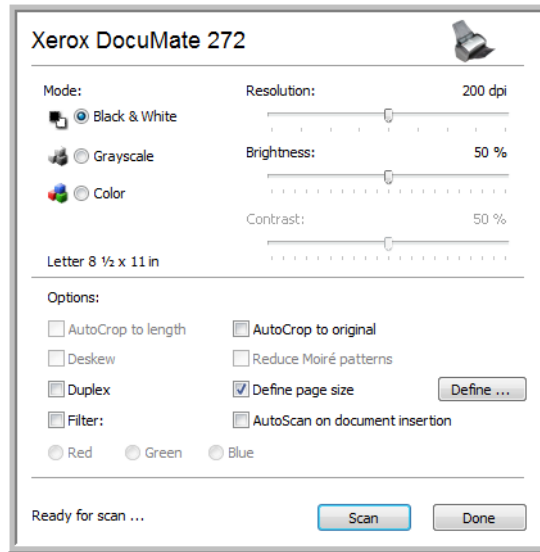

2. Set the resolution to 200 or 300 dpi to ensure good image quality.
3. Choose **AutoCrop to original** to scan the proper size for the card.
4. Choose **Duplex** to scan both sides of the card.
To scan a single side, uncheck **Duplex**.
5. Insert the card lengthwise into the Card Reader slot on the back of the scanner.



6. If the AutoScan feature is turned on scanning begins.
7. If the AutoScan feature is not turned on click the **Scan** button.
The scanning starts and a progress box shows the image.
When scanning is finished, a thumbnail image of the scanned card appears in the TWAIN application.

- The image of the card is automatically rotated 90° so it is easily readable when it appears.



Insert the card into the scanner lengthwise.



When scanning is finished, the scanner will automatically rotate the image so it's easily readable in the Destination Application.

- The rotated card image appears in the TWAIN application, in this case the PaperPort desktop shows a thumbnail of the scanned card.

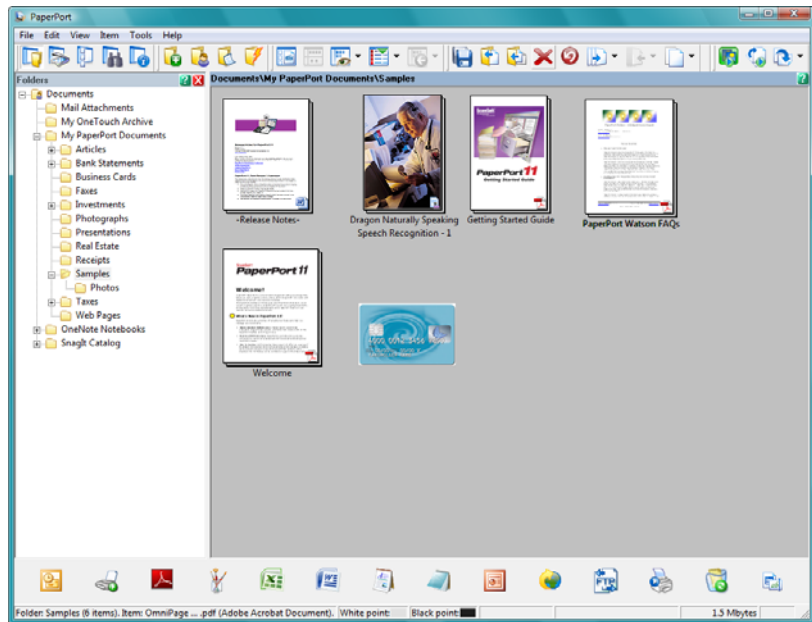

NOTE: Do not use the Card Reader to scan business cards. They can jam the Reader's mechanism. Use the Automatic Document Feeder to scan business cards.

Display the Device Configuration



1. Click the **Xerox DocuMate 272** icon in the top right corner of the TWAIN interface.

The Device configuration window opens and shows the information about your scanner.

See the section “Checking the Hardware and Setting the Lamp Power Saving” on page 79 for more information about the device settings.

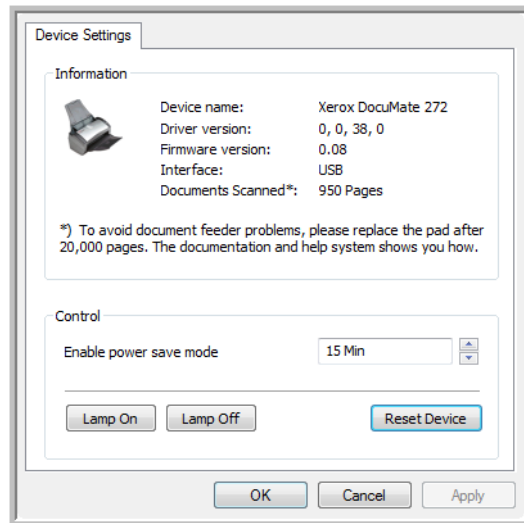

Setting Up PaperPort to Work With Your Scanner

When you select a scanning option from PaperPort's Scanner drop-down list, either **Twain: Xerox DocuMate 272** or **WIA: Xerox DocuMate 272** (Windows XP only), the **Scan** button at the bottom of the panel should become active. If it doesn't you need to set up PaperPort to work with your scanner.

If this Scan button is not active, you need to set up PaperPort to be able to access your scanner.

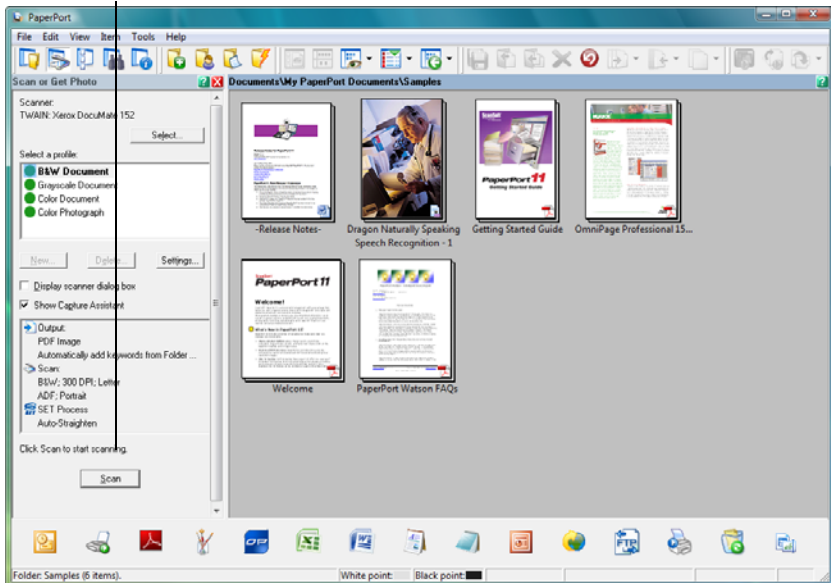

NOTE: Setting up PaperPort is a one-time-only process for each option from the Scanner drop-down list. Therefore, you may have to set up PaperPort once each for **Twain: Xerox DocuMate 272** and **WIA: Xerox DocuMate 272**. The setup process, described below, is the same for each option. You will not have to set up PaperPort again for either option unless you uninstall the scanner and PaperPort software, then re-install them.

To set up your scanner:

1. From the Scanner drop-down list, select one of the options, such as **Twain: Xerox DocuMate 272**.
2. Click the **Setup** button.

A window opens to begin the setup process.

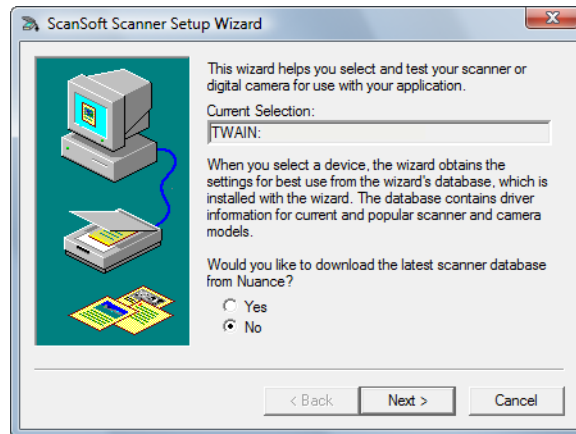

3. Click **Yes** then click **Next**.

The next window offers you the option to run hardware diagnostics.

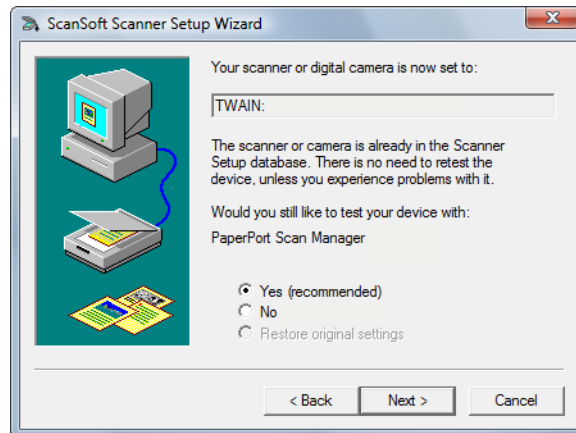

4. Click **Yes (recommended)** then click **Next**.

The next window is for checking the connection between your scanner and the computer.

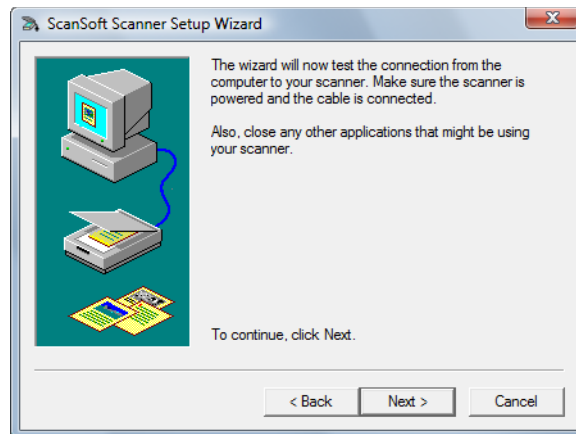

5. Click **Next**.

After the Setup Wizard checks the connections, the next window is displayed. It has a series of setup options, but only the Basic scan test is necessary because your scanner was already tested and calibrated when you installed the One Touch 4.0 software

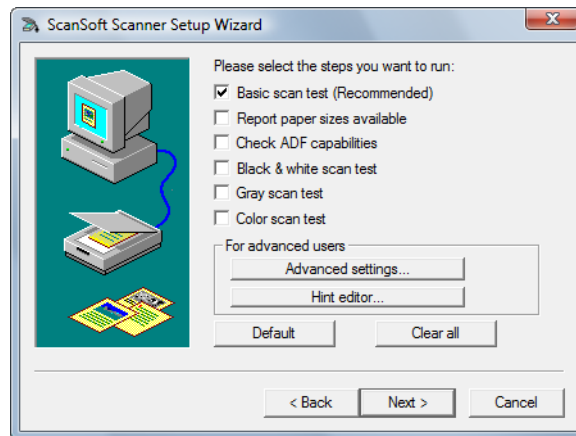

6. Click **Next**.

The TWAIN Interface opens.

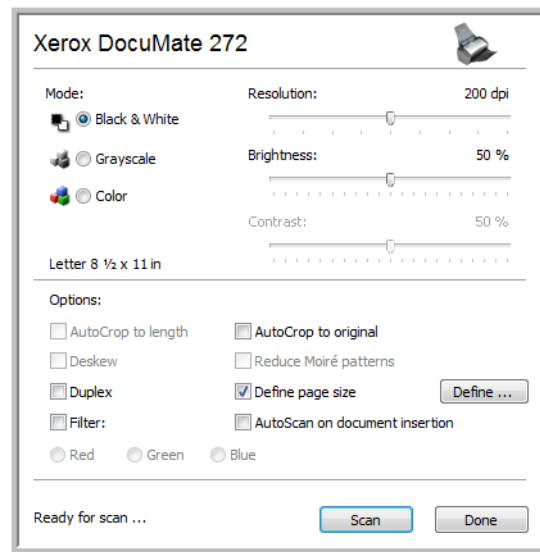

NOTE: If you are setting up the scanner for WIA, the WIA interface opens instead.

7. Insert a *single* page into the scanner, face-down, and the **Scan** button on the TWAIN Interface will become active.



8. Click the **Scan** button on the TWAIN interface.
The Setup Wizard runs the scan test.
A message window opens that says “Basic scan test passed.”
9. Click **Next** on the message window.

The final Setup window opens to let you know the setup process is finished.

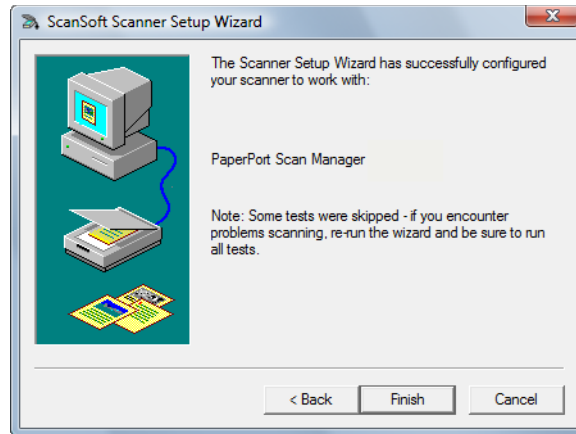

10. Click **Finish**.

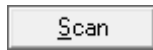

PaperPort is now setup for the scanning option you selected (in the example above, it's the TWAIN option) and the **Scan** button on the PaperPort window will now become active.

Scanning with the WIA Interface

Microsoft Windows XP and Windows Vista include their own scanning interface—known as Windows Image Acquisition (WIA)—for acquiring images from scanners, digital cameras, and other digital devices.

This section shows how to use Microsoft Paint to scan using the WIA interface, but you can use PaperPort and other Windows applications as well.

NOTE: Duplex (two-sided) scanning is not available from WIA.

To scan using WIA from Microsoft Paint:

1. On the Windows taskbar, click **Start**, point to **Programs**, point to **Accessories**, and then click **Paint**.

The Paint window opens.

2. From the **File** menu choose **From Scanner or Camera**.

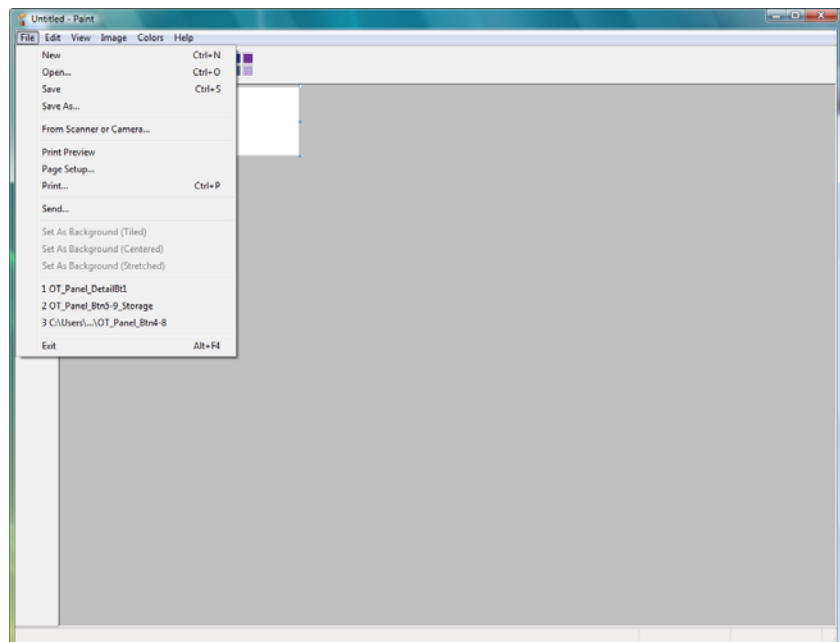

The **Scan using Xerox DocuMate 272** window opens. Use this window to select scanning options and start the scan process.

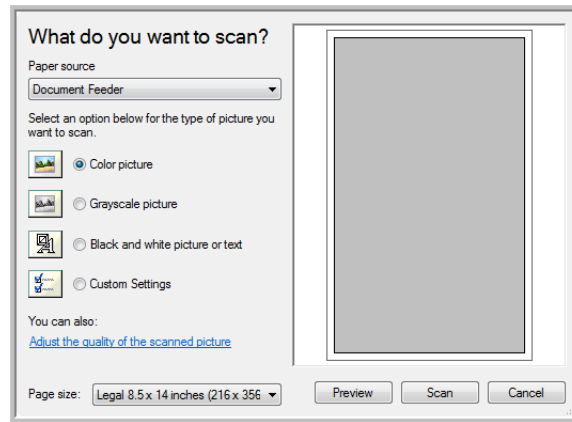

3. Click the button most appropriate for the item you're scanning.
4. Select a paper size from the Page Size list.
5. Click **Preview** to preview the image before scanning.

The image is displayed on the right side of the window.

NOTE: If you preview when scanning a stack of documents, the first page of the stack feeds through the ADF for the preview. After adjusting the scanner settings, replace that page on the stack so it is scanned with the rest of the pages.

6. Adjust settings of the previewed image as desired:
 - Change the button selection for the type of image.
 - Adjust the custom settings; refer to the next section, "Fine Tuning Your Scans".
 - Change the size of the scanned image. To do this, click and hold the mouse pointer over one of the four sizing-boxes on the corners of the previewed image. Then drag the box to increase or decrease the size of the image.
7. Preview the image again. When you are satisfied with the image, click the **Scan** button.

8. The scanned images will appear in Microsoft Paint (or other WIA application you're using).

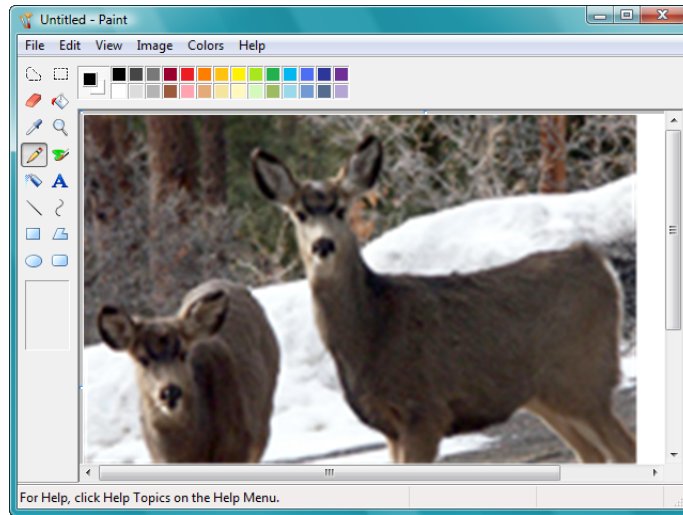

Fine Tuning Your Scans

You can select new settings before you scan an item to fine tune exactly how you want to scan it.

To select the scanner settings before you scan:

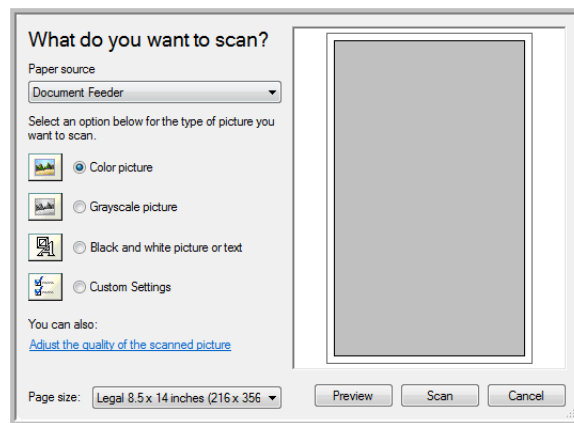

1. On the scan window, click **Adjust the quality of the scanned picture**.

The Advanced Properties dialog box opens.

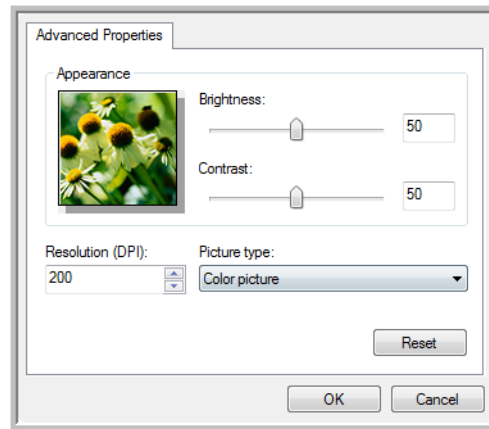

2. Select the options for scanning.

Brightness and **Contrast**—Drag the sliders to the right or left to adjust the brightness and contrast of the scanned image. The Contrast setting does not apply to the setting **Black and White picture or text**.

Resolution (DPI)—Click the menu arrow and choose the dots per inch (dpi) of the resolution. The maximum resolution is 600 dpi; the minimum is 50 dpi. The higher the dpi setting, the sharper and clearer the scanned image. However, higher dpi settings take longer to scan and produce larger files for the scanned images.

Picture type—Click the menu arrow and choose the most appropriate type for the item you're scanning.

3. Click **OK**.

The Custom Settings button is now set to scan with the options you selected.

If you want to reset the settings and start over, click **Reset**.

Scanning with the ISIS Interface

You can use the ISIS interface from QuickScan or any other application that will access the ISIS driver. Note that the ISIS interface for each application varies depending on the application. Please refer to that software application's User Guide for instructions on scanning with the ISIS interface. The QuickScan User's Guide is available on the Disc 1 CD that you received with the scanner.

Accessing the ISIS interface in QuickScan

Open the QuickScan software to access the ISIS driver scanning options. Please note that you may see the following warning message:



1. Please disregard this message and click **Continue**.

The Pixel Translations ISIS drivers were installed correctly during the installation of your Xerox DocuMate 272 scanner.

The Scanner Selection dialog box will then open.

2. Select **Xerox DocuMate 272** from the list of scanners and click **OK**.

Your scanner is then ready to work with the QuickScan ISIS driver.

Maintenance

This section contains information on maintenance, troubleshooting, uninstalling, scanner specifications, and spare parts.

Cleaning the Automatic Document Feeder

You may need to clean the ADF feed mechanism if your documents do not feed easily into the ADF, or several feed in at the same time.

To clean the ADF:

1. Dampen a soft cloth with some isopropyl rubbing alcohol (95%).
2. Press the ADF cover release on the top left of the scanner body to open the Automatic Document Feeder cover.

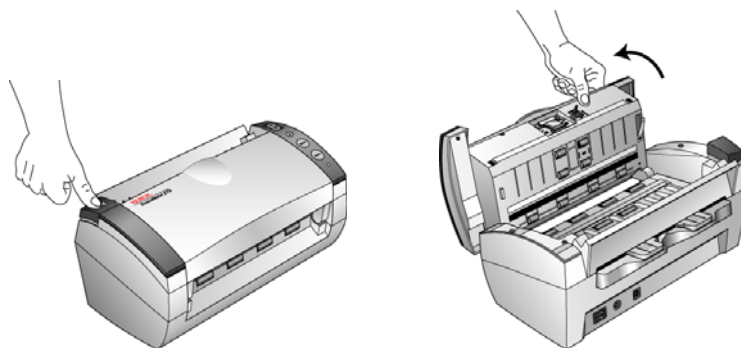

3. Wipe the feed roller from side to side. Rotate the roller to clean its entire surface.

NOTE: Please be careful when cleaning the roller. The roller is designed to rotate in one direction only. As you're cleaning the roller, make sure it rotates easily, and continue rotating it in that direction while wiping it clean. Do NOT force the roller to rotate in the opposite direction. Forcing the roller to rotate will damage it, and may cause the scanner to feed pages incorrectly.

4. Wipe the pad from top to bottom. Be careful not to snag the cloth on the springs on either side of the pad.
5. Close the cover when you're finished.

Clearing Paper Jams

If your scanner stops scanning due to a paper jam in the Automatic Document Feeder, a warning dialog box opens after a few moments.

To clear a paper jam:

1. Press the ADF cover release on the top-left of the scanner body to open the Automatic Document Feeder cover.

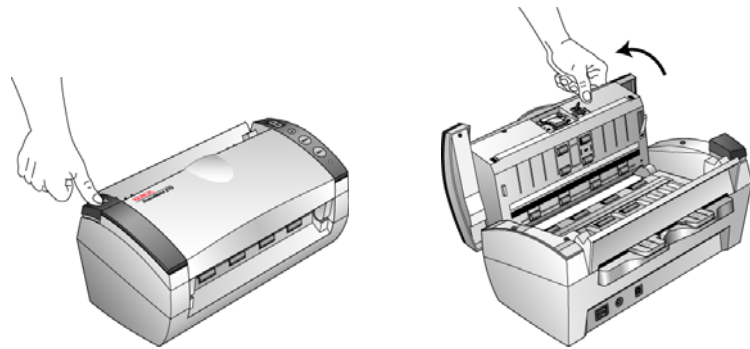

2. Remove the jammed paper and close the cover.

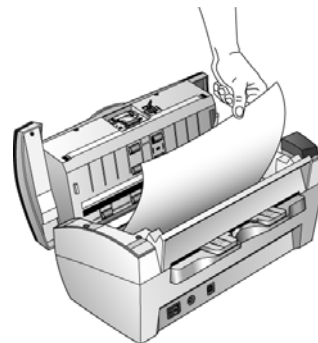

To reduce the number of paper jams, smooth and straighten the paper before scanning and adjust the guides to the paper size.

Replacing the ADF Pad Assembly

The ADF pad may wear out and is designed to be a user-replaceable part. Problems with documents feeding into the ADF is an indication that the pad is wearing thin.



See the “Xerox DocuMate 272 Scanner Parts List” on page 113 for ordering information.

To replace the ADF Pad assembly:

1. Press the ADF cover release on the top left of the scanner body to open the Automatic Document Feeder cover.

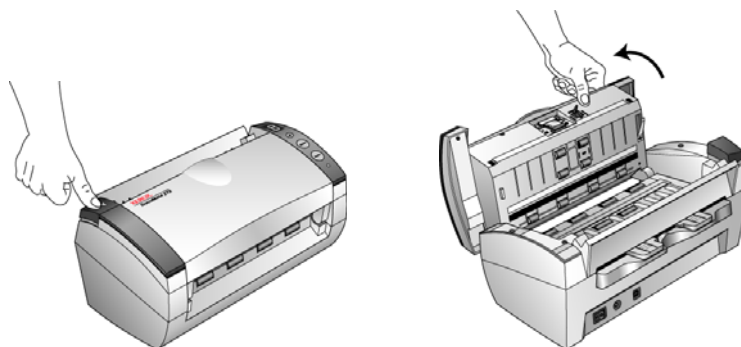

2. Squeeze the plastic clamps that hold the pad assembly in place and lift the pad up and out

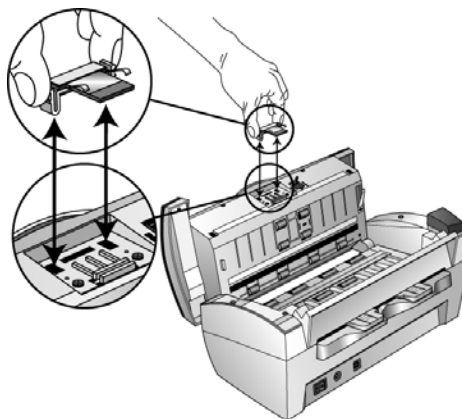

3. Reverse the procedure to replace the new pad into its slots.

Troubleshooting

In addition to the troubleshooting information contained in this section, please see the Readme file on your installation CD. The Readme file contains additional information that may help you diagnose problems with the scanner.

If you try the troubleshooting procedures described in this section and in the Readme file, and the scanner still has problems, you may have a malfunctioning scanner. Refer to the technical support card that you received with your scanner. Also visit our web site at www.xeroxscanners.com for additional technical information.

Problem: The scanner won't scan. What's wrong?

Check for one of these possible problems:

- **Are the cables loose or not plugged in securely?** Inspect the cable connections. Make sure the cables are plugged in securely.
- **Is the scanner's status light on?** Turn on the scanner's power. If the status light doesn't come on, plug the power supply into another electrical outlet.
- **Did you restart the computer after installing the software?** If you didn't restart the computer, it may not have loaded all of the software files. Try restarting your computer.
- **Did you plug the scanner into a USB hub?** If you're using a USB hub to connect the scanner, the hub must have its own power supply. If the hub does not have its own power supply, plug the scanner into a USB port on the computer.
- **Did you select another scanning source in the PaperPort Scan Pane?** If you use multiple devices with your computer, you may have selected another source for images. Start the PaperPort software and click the **Scan** icon, then make sure **Xerox DocuMate 272** is selected as the scanner.

Problem: During installation I got the error message: PaperPort Installation is not complete. What do I do?

The installation procedure was not successful. You need to reinstall the PaperPort software.

Problem: The installation will not complete successfully. If installation finishes, the scanner's One Touch 4.0 options do not seem to work properly. What do I do?

A likely cause is that some driver programs are already installed on your computer for another scanner. They are interfering with the installation and One Touch options, and you need to remove those other drivers and re-install your Xerox DocuMate 272 scanner. Please see the documentation that you received with the other scanner for the steps to remove its driver programs. You can also use the basic steps in the section "Uninstalling Your Scanner" on page 110, but in Step 3, instead of uninstalling One Touch 4.0, uninstall the other scanner's driver programs. After uninstalling the other scanner's driver programs, uninstall One Touch 4.0 using the steps on page 110, then reinstall it using the steps on page 7.

Problem: I got the error message: PaperPort cannot allocate enough memory to perform internal critical operations. What do I do?

Close any other active applications so that additional memory is available. If you click Continue, PaperPort moves the file to the PaperPort data directory and renames the file with the prefix "bad". This allows you to recover the file later.

To recover the file, you can import it into PaperPort by using the Import command in the File menu.

Problem: How do I uninstall PaperPort?

See the section "Uninstalling Your Scanner" on page 110. Uninstalling does not delete your scanned items, and they remain in the PaperPort Data folder.

Status Light Troubleshooting Codes

The status light indicates the current state of the scanner. A green status light indicates the normal state of the scanner. A red status light indicates that there is a hardware issue. Descriptions of the most common patterns are listed below.

Normal Operation

- **Blinking green:** indicates the scanner is waking up from power saving and preparing to scan.
- **Steady green:** indicates the scanner is ready to scan.

Error Codes

If your scanner experiences hardware problems, the status light will blink red, and the LED flashes an “E” and then the error code number.

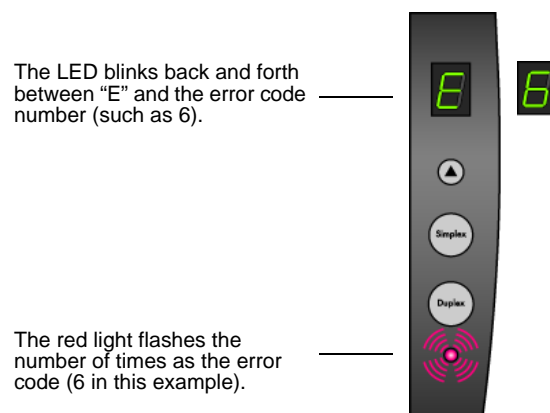

The E-code number indicates what the hardware issue is. Use the table listed on the next page as a reference for resolving hardware issues.

In all cases you should turn off your scanner and check your scanner setup. Open the scanner and make sure your input tray is fully seated in the scanner casing, make sure your ADF pad is securely snapped in place, verify the connections to the PC and wall.

Error Code	Problem Description	Solution
0	Scanner is not connected to the computer. (The LED does not flash "E" and the status light remains green.)	A cable may be loose. Check that the scanner's cables are correctly attached to the computer. If the scanner still does not connect, re-boot the computer.
4 or 5	The scanner lamp is either turned off or the lamp has not warmed up enough to initiate scanning.	In the One Touch hardware properties turn the scanner lamp on. See page 79 for instructions. If the lamp is already on, turn the lamp off then on again. If the problem persists and your scanner's power is plugged into a surge protector or UPS battery backup, try plugging the scanner power directly into a wall outlet.
6	The scanner's cover is open.	Close the scanner cover and make sure it attaches completely.
7 or 8	The lamp in the scanner body or the ADF portion of the scanner has malfunctioned.	Make sure that the lamp has not been turned off manually. See the steps on page 79 to turn the lamp on and off. Re-boot your computer. If the problem persists, contact Xerox Technical Support.
9	Paper jam	See "Clearing Paper Jams" on page 104.
All Other Codes	An internal part in the scanner may have malfunctioned.	Turn off the power to your scanner, then turn it back on again. If the problem persists, contact Xerox Technical Support.

Uninstalling Your Scanner

To uninstall the Xerox DocuMate 272 scanner, remove the scanner software, PaperPort, or any other scanning software provided with the scanner.

Uninstalling the Scanner and One Touch Software

1. On the Windows taskbar, click **Start**, point to **Settings**, then click **Control Panel**.
2. *Windows 2000 and Windows XP:* Double-click the **Add/Remove Programs** icon.
Windows Vista: Double-click the **Programs and Features** icon.
3. From the list of programs, select **One Touch 4.0**.
Click the **Change/Remove** button.
4. Click **Yes** when asked to confirm that you want to remove these software programs.
5. Follow these same steps to select and remove the **Kofax Virtual ReScan 4.10** and **OneTouch 4.0 ScanSoft OmniPage OCR** modules from the installed programs list.
6. The One Touch 4.0 software and modules will now be removed from your computer.
7. **Unplug the USB cable from the scanner.**
8. Close all open windows and restart your computer.

Uninstalling the PaperPort and OmniPage Software

1. On the Windows taskbar, click **Start**, point to **Settings**, then click **Control Panel**.
2. *Windows 2000 and XP:* Double-click the **Add or Remove Programs** icon.
Windows Vista: Double-click the **Programs and Features** icon.
3. Select **PaperPort** or **OmniPage** and click **Remove**.
4. A message window opens, asking if you are sure you want to remove the software from your computer. Click **Yes**.
5. Close all open windows and restart your computer.

To Install Another Driver

Before you can install another driver for your scanner, you must remove the currently installed driver first. Then the new driver can be installed.

1. Uninstall the One Touch 4.0 driver.
 - a. Open the Windows Control Panel.
 - b. *Windows 2000 and XP:* Double-click on **Add/Remove Programs**.
Windows Vista: Double-click on **Programs and Features**.
 - c. Select One Touch 4.0 then click on the **Remove** button.
 - d. An “Add or Remove” message box opens and asks if you are sure you want to remove One Touch 4.0 from your computer. Click **Yes**.

The One Touch 4.0 software is removed from your computer.

2. **Unplug the scanner USB cable.**
3. Reboot (restart) your computer.
4. Follow the instructions in “Step 2: Install the Software” on page 7 of this User Guide and follow steps for installing one of the other driver options.







NOTE: The One Touch 4.0 driver is required for the scanner’s buttons to function. If you select a driver without One Touch 4.0, the scanner buttons will not initiate scanning.

Xerox DocuMate 272 Scanner Specifications

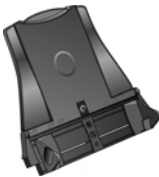
Optical resolution	600 x 1200 dpi
Bit depth	48-bit color (internal)
Maximum item size	8.5" x 14"
Minimum item size	3.5" x 2" (Automatic Document Feeder)
Scan method	Automatic Document Feeder (ADF)
ADF specifications	
Scanning Speed	Up to 25 pages per minute. Up to 50 images per minute @ 200 dpi B&W
Capacity	50 sheets
Paper Thickness	16 - 28 lbs. (0.002" - 0.006")
Light source	Cold cathode fluorescent lamp
Interface	USB 2.0 High Speed
Scanner dimensions	
Height	12.5 inches (31.75 cm)
Width	13.25 inches (33.66 cm)
Length	17 inches (43.18 cm)
Weight	8.6 pounds (3.91 kg)
Operating temperature	50°–104° F (5°–35° C without condensation)
Relative humidity	40%–70% (@35° C without condensation)
Power adaptor	DC Jack, 24Vdc/2.0A (48W), 100-240Vac, Energy Star and RoHS compliant
Power consumption	≤ 40 Watts (during operation); ≤ 25 Watts (on standby); ≤ 6 Watts (power save after 15 minutes without scanning, can be adjusted by software); ≤ 1 Watt (power off)
Power cord	AC, US, 3P, 10A/125V, 180 cm, 3C, 18AWG, RoHS compliant
USB cable	185 cm, 28AWG, with core, RoHS compliant
Safety and agency certifications	UL, C-UL, FCC Class B, CE, TUV/GS, WEEE

Xerox DocuMate 272 Scanner Parts List

Please use the following part names and numbers when ordering replacements for your scanner.

	Part Name	Part Number
	Paper Guide	57-0104-000
	Output Tray	57-0105-000
	ADF Pad	57-0103-000
	USB Cable	35-0107-000
	AC Power Cord	35-0103-000
	Power Supply	37-0076-000
	Buttons Label	09-0631-000

Appendix A Notices

It's Illegal in the USA

Congress, by statute, has forbidden the reproduction of the following subjects under certain circumstances. Penalties of fine or imprisonment may be imposed on those guilty of making such reproductions.

1. Obligations or Securities of the United States Government, such as:

Certificates of Indebtedness	National Bank Currency
Coupons from Bonds	Federal Reserve Bank Notes
Silver Certificates	Gold Certificates
United States Bonds	Treasury Notes
Federal Reserve Notes	Fractional Notes
Certificates of Deposit	Paper Money

Bonds and Obligations of certain agencies of the government, such as FHA, etc.

Bonds. (U.S. Savings Bonds may be photographed only for publicity purposes in connection with the campaign for the sale of such bonds.)

Internal Revenue Stamps. (If it is necessary to reproduce a legal document on which there is a canceled revenue stamp, this may be done provided the reproduction of the document is performed for lawful purposes.)

Postage Stamps, canceled or uncanceled. (For philatelic purposes, Postage Stamps may be photographed, provided the reproduction is in black and white and is less than 75% or more than 150% of the linear dimensions of the original.)

Postal Money Orders.

Bills, Checks, or Drafts of money drawn by or upon authorized officers of the United States.

Stamps and other representatives of value, of whatever denomination, which have been or may be issued under any Act of Congress.

2. Adjusted Compensation Certificates for Veterans of the World Wars.
3. Obligations or Securities of any Foreign Government, Bank, or Corporation.

-
4. Copyrighted material, unless permission of the copyright owner has been obtained or the reproduction falls within the “fair use” or library reproduction rights provisions of the copyright law. Further information of these provisions may be obtained from the Copyright Office, Library of Congress, Washington, D.C. 20559. Ask for Circular R21.
 5. Certificates of Citizenship or Naturalization. (Foreign Naturalization Certificates may be photographed.)
 6. Passports. (Foreign Passports may be photographed.)
 7. Immigration Papers.
 8. Draft Registration Cards.
 9. Selective Service Induction Papers that bear any of the following Registrant’s information:

Earnings or Income	Dependency Status
Court Record	Previous military service
Physical or mental condition	

Exception: U. S. Army and Navy discharge certificates may be photographed.
 10. Badges, Identification Cards, Passes, or Insignia carried by military personnel, or by members of the various Federal Departments, such as FBI, Treasury, etc. (unless photograph is ordered by the head of such department or bureau.)

Reproducing the following is also prohibited in certain states:
Automobile Licenses — Drivers’ Licenses — Automobile
Certificates of Title.

The above list is not all inclusive, and no liability is assumed for its completeness or accuracy. In case of doubt, consult your attorney.

It’s Illegal in Canada

Parliament, by statute, has forbidden the reproduction of the following subjects under certain circumstances. Penalties of fines or imprisonment may be imposed on those guilty of making such copies.

1. Current bank notes or current paper money.
2. Obligations or securities of a government or bank.
3. Exchequer bill paper or revenue paper.
4. The public seal of Canada or of a province, or the seal of a public body or authority in Canada, or of a court of law.

-
5. Proclamations, orders, regulations or appointments, or notices thereof (with intent to falsely cause same to purport to have been printed by the Queen's Printer for Canada, or the equivalent printer for a province).
 6. Marks, brands, seals, wrappers or designs used by or on behalf of the Government of Canada or of a province, the government of a state other than Canada or a department, board, Commission or agency established by the Government of Canada or of a province or of a government of a state other than Canada.
 7. Impressed or adhesive stamps used for the purpose of revenue by the Government of Canada or of a province or by the government of a state other than Canada.
 8. Documents, registers or records kept by public officials charged with the duty of making or issuing certified copies thereof, where the reproduction falsely purports to be a certified copy thereof.
 9. Copyrighted material or trademarks of any manner or kind without the consent of the copyright or trademark owner.

The above list is provided for your convenience and assistance, but it is not all inclusive, and no liability is assumed for its completeness or accuracy. In case of doubt, consult your solicitor.

Federal Communications Commission (FCC) for USA

This equipment has been tested and found to comply with the limits for the class B digital device, pursuant to part 15 of the FCC Rules. These limits are designed to provide reasonable protection against interference in a residential installation. This equipment generates, uses and can radiate radio frequency energy and if not installed, and used in accordance with the instructions, may cause harmful interference to radio communications. However, there is no guarantee that interference will not occur in a particular installation. If this equipment does cause harmful interference to radio or television reception, which can be determined by turning the equipment off and on, the user is encouraged to try and correct the interference by one or more of the following measures:

Reorient or relocate the receiving antenna.

Increase the separation between the equipment and receiver.

Connect the equipment into an outlet on a circuit different from that to which the receiver is connected.

Consult the dealer or an experienced radio/TV technician for help.

This equipment has been certified to comply with the limits for a class B computing device, pursuant to FCC Rules. In order to maintain compliance with FCC regulations, shielded cables must

be used with this equipment. Operation with non-approved equipment or unshielded cables is likely to result in interference to radio and TV reception. The user is cautioned that changes and modifications made to the equipment without the approval of manufacturer could void the user's authority to operate this equipment.

This device complies with part 15 of the FCC Rules. Operation is subject to the following two conditions: (1) This device may not cause harmful interference, and (2) this device must accept any interference received, including interference that may cause undesired operation.

Energy Star for the USA



As an ENERGY STAR partner, Xerox Corporation has determined that this product meets the ENERGY STAR guidelines for energy efficiency.

ENERGY STAR® is a US registered trademark.

The ENERGY STAR program is a team effort between the Environmental Protection Agency and the office equipment industry to promote energy-efficient personal computers, monitors, printers, digital presses, fax machines and copiers. Reducing the energy consumption of this equipment will help combat smog, acid rain and long-term changes to the climate by decreasing the emissions that result from generating electricity.

RoHS and WEEE Compliance

This product is compliant with RoHS Regulations of the European Parliament and Council Directive on the Restrictions of the Use of Certain Hazardous Substances in Electrical and Electronic Equipment (2002/95/EC), and with the Waste Electrical and Electronic Equipment (WEEE) Directive (2002/96/EC).

Product recycling and disposal for USA

Xerox operates a worldwide equipment takeback and reuse/recycle program. Contact your Xerox sales representative (1-800-ASK-XEROX) to determine whether this Xerox product is part of the program.

If your product is not part of the Xerox program and you are managing its disposal, please note that the product may contain lead and other materials whose disposal may be regulated due to environmental considerations. For recycling and disposal information, contact your local authorities.

Index

A

ADF

cleaning **103**

ADF pad assembly

replace **105**

Advanced Properties **101**

Archive button **76**

aspect ratio **56**

Autocrop to Original **53, 86**

AutoRotate image **56**

B

bit depth **112**

Black&White **52, 85**

BMP **44**

Brightness **52, 86, 101**

Burn to CD **41, 70**

Destination Application **70**

button options **48**

button settings **35**

C

card reader **30, 90**

CD-ROM drive **3**

Color **52, 85**

color configuration **85**

Color Document **35**

color filter **55, 86**

Comma Delimited **46**

components **2**

computer specifications **3**

Configure Before Scan **63**

Contrast **52, 86, 101**

create single page items check box **84**

csv file format **46**

D

Destination Application **23, 32**

OCR **35**

text file format **45**

Destination Selector **24**

Device Settings **52, 56**

Document Format **32**

Document Management **48**

documentation **3**

dpi **101**

Duplex **54**

duplex button **2, 22, 23, 24**

E

eMail **49**

eMail Properties **42**

error codes **108**

Excel Spreadsheet **46**

F

Fax and Print **49**

file format **46**

file storage location **76**

Format and Page(s) **36**

full feature install **11**

G

gamma **55**

grayed out options **33**

GrayScale **52, 85**

H

help **3, 84**

htm file format **46**

HTML Document **46**

HTML page **75**

HTML Web Page **74**

hue **55**

I

Image Documents Properties **40**

Image Editors **48**

image file **44**

image file format **44**

improvements and settings **53**

installation **4**

invert image **54**

ISIS **18**

J

JPG **44**

JPG file size **44**

K

Kofax VRS **18**

L

lamp malfunction **109**
Lamp timeout setting **80**
LED number **22, 23**
Link Properties **37**

M

Microsoft Internet Explorer **74**
Microsoft Outlook **42**
Moire Patterns **53, 86**
monitor **3**

N

Normal PDF **47, 68**
nPDF **35, 44, 47, 68**

O

OCR **45**
 optical character recognition **66**
 storage **78**
OCR button **67**
OmniPage Pro **40, 47, 66**
on/off switch **15**
One Touch Button Panel **25, 26, 76**
 Button View **27**
 Detail View **27**
 Hardware View **27**
 initial settings **29**
 names **28, 47**
 OCR **67**
One Touch icon **26, 27, 32**
One Touch Properties window **25, 32, 37**
 options **48, 51**

P

Page Format
 HTML **74**
page format options **43**
page size **53, 87**
paper guide **5**
paper jam **104, 109**
PaperPort **81**
 help topics **84**

Scan pane **83**
PaperPort Properties **37**
PDF **44, 49**
PDF file size **44**
Picture type **101**
power saving **80**
Preview button **99**

R

Resolution **52, 85, 101**
Rich Text Format **46**
rtf file format **46**

S

saturation **55**
scan
 file name **83**
 from PaperPort **81**
Scan Configuration **32**
scan with event forwarding **72**
scanner
 components **2**
 connecting **13**
 troubleshooting **106**
 uninstall **110**
Searchable PDF **47, 68**
Select Configuration **34, 35**
Select Destination **33, 35, 48**
Select Format and Page(s) **34**
setup **4**
Show All Destinations **48**
Show Hardware **79**
Simple Text **46**
simplex button **2, 22, 23, 24**
size **53, 87**
skewed page **53, 86**
skip blank originals **54**
sPDF **35, 44, 47, 68**
spreadsheets
 OCR **67**
status light **15, 16, 106**
 troubleshooting codes **108**
Sti event forwarding **49**
Storage and CD-R/W **49**
Storage Properties **41**
Straighten Image **54**
system requirements **3**

T

Text Documents Properties **38**
Text Editors **49**
text file format **45**

Text Formats **45**
TIFF **44**
Transfer to Storage **76**
troubleshooting **106**
TWAIN **63, 73**
TWAIN standard **81**

U

uninstall **110**
USB port **14**

W

watermark, remove **55, 86**
WIA **63, 98**
Windows Image Acquisition **98**
Word Document **46**

X

xls file format **46**

