

05-1042-000
JUNE 2024

Xerox® D50 Scanner

Scanner User Guide for Microsoft® Windows® and Mac OS X®

©2024 Xerox Corporation. All rights reserved. Xerox® is a trademark of Xerox Corporation in the United States and/or other countries and is used under license from Xerox Corporation. Visioneer is an authorized trademark licensee of Xerox®. Visioneer is a trademark of Visioneer, Inc. All other trademarks are the property of their respective owners and are hereby acknowledged. BR40377

Reproduction, adaptation, or translation without prior written permission is prohibited, except as allowed under the copyright laws. Copyright protection claimed includes all forms of matters of copyrightable materials and information now allowed by statutory or judicial law or hereinafter granted, including without limitation, material generated from the software programs which are displayed on the screen such as styles, templates, icons, screen displays, looks, etc.

Document Version: 05-1042-000 (June 2024)

ISIS® is a registered trademark of EMC²® Corporation in the United States and/or other countries.

Adobe®, Adobe® Acrobat®, Adobe® Reader®, and the Adobe® PDF logo are registered trademarks of Adobe Systems Incorporated in the United States and/or other countries.

Post-It® is a registered trademark of 3M in the United States and/or other countries.

Microsoft is a U.S. registered trademark of Microsoft Corporation. Windows™ and SharePoint® are registered trademarks of Microsoft Corporation.

ZyINDEX is a registered trademark of ZyLAB International, Inc. ZyINDEX toolkit portions, Copyright © 1990-1998, ZyLAB International, Inc.

TWAIN™ is a trademark of TWAIN Working Group.

Intel® and Pentium® are trademarks of Intel Corporation in the United States and/or other countries.

Universal Serial Bus is a trademark of USB Implementers Forum, Inc. (USB-IF).

Kensington® is a registered trademark of ACCO Brands Corporation.

Changes are periodically made to this document. Changes, technical inaccuracies, and typographic errors will be corrected in subsequent editions. Information is subject to change without notice and does not represent a commitment on the part of Visioneer.

The software described is furnished under a licensing agreement. The software may be used or copied only in accordance with the terms of such an agreement. It is against the law to copy the software on any medium except as specifically allowed in the licensing agreement. No part of this document may be reproduced or transmitted in any form or by any means, electronic or mechanical, including photocopying, recording, or information storage and retrieval systems, or translated to another language, for any purpose other than the licensee's personal use and as specifically allowed in the licensing agreement, without the express written permission of Visioneer.

Restricted Rights Legend

Use, duplication, or disclosure is subject to restrictions as set forth in contract subdivision (c)(1)(ii) of the Rights in Technical Data and Computer Software Clause 52.227-FAR14. Material scanned by this product may be protected by governmental laws and other regulations, such as copyright laws. The customer is solely responsible for complying with all such laws and regulations.

Table of Contents

1-Safety	1-1
Safety Introduction	1-1
Operational Safety Information	1-1
Electrical Information	1-2
Warning - Electrical Safety Information	1-2
Electrical Supply	1-2
Disconnect Device	1-3
Emergency Power Off	1-3
Maintenance Information	1-3
Product Safety Certification	1-3
Environmental Health and Safety Contacts	1-4
2-Welcome	2-1
What's in the Box	2-1
System Requirements	2-1
Documentation	2-2
Xerox® D50 Scanner Features	2-2
3-Assemble the Scanner	3-1
Unpacking the Xerox® D50 Scanner	3-1
Connect the Power Cord	3-2
Connect the USB Cable	3-2
Safety Lock	3-3
4-Installation	4-1
Windows	4-1
USB Driver Installation	4-1
Mac	4-4
Installing Additional Applications	4-9
View the User Guides	4-9
Register Your Scanner	4-10
5-Loading Documents to Scan	5-1
Supported Document Types	5-1
Documents to Avoid Scanning	5-2
Unsupported Document Types	5-2
Scanning from the Automatic Document Feeder (ADF)	5-3
Scanning Regular Documents	5-3
Scanning Dot Matrix Printer Paper	5-4
Scanning Interfaces	5-5
Windows	5-5
Mac	5-6
6-Maintenance	6-1
Safety Precautions	6-1
Hardware Properties	6-1
Windows	6-2
Mac	6-3
Adjusting the Paper Guides	6-4

Clearing Paper Jams.....	6-5
Cleaning the Scanner.....	6-6
Cleaning Inside the Automatic Document Feeder	6-6
Replacing the Reverse (Separation) Roller	6-7
Replacing the ADF (Feed) Roller	6-10
Troubleshooting.....	6-14
Error Light Troubleshooting Codes.....	6-16
Uninstalling Your Scanner	6-17
Windows.....	6-17
Mac.....	6-18
Xerox® D50 Scanner Specifications	6-19
Xerox® D50 Scanner Parts List.....	6-20
7-Appendix A: Regulatory Information	7-1
Basic Regulations.....	7-1
United States (FCC Regulations)	7-1
Great Britain	7-1
European Union.....	7-2
Turkey (RoHS Regulation)	7-2
Copy Regulations.....	7-2
United States	7-2
Canada	7-3
Other Countries.....	7-4
8-Appendix B: Compliance Information	8-1
Product Recycling & Disposal.....	8-1
USA & Canada.....	8-1
European Union.....	8-1
ENERGY STAR for the USA	8-1

1. Safety

Safety Introduction

Notices and Safety

Please read the following instructions carefully before operating the machine and refer to them as needed to ensure the continued safe operation of your machine.

Your Xerox® D50 Scanner and supplies have been designed and tested to meet strict safety requirements. These include safety agency evaluation and certification, and compliance with electromagnetic regulations and established environmental standards.

 **WARNING! The safety and environment testing and performance of this product have been verified using Xerox® materials only. Unauthorized alterations, which may include the addition of new functions or connection of external devices, may impact the product certification. Please contact your Xerox representative for more information.**

Operational Safety Information

Your Xerox® D50 Scanner and supplies have been designed and tested to meet strict safety requirements. These include safety agency examination, approval, and compliance with established environmental standards.

To ensure the continued safe operation of your Xerox® D50 Scanner, follow these safety guidelines at all times:

Do these:

- Always follow all warnings and instructions that are marked on or supplied with the equipment.
- Always use materials specifically designated for this product, the use of other materials may result in poor performance and create a hazardous situation. Do not use aerosol cleaners, they may be explosive and flammable under certain conditions.
- Always exercise care when moving or relocating equipment.
- Always locate the machine on a solid support surface that has adequate strength to support the weight of the machine.
- Always locate the machine in an area that has adequate ventilation and room for servicing.
- Always unplug this equipment from the electrical outlet before cleaning.

Note: Your Xerox® D50 Scanner is equipped with an energy saving device to conserve power when the machine is not in use. The machine may be left on continuously.

Do not do these:

- Never use a ground adapter plug to connect the equipment to a power outlet that lacks a ground connection terminal.
- Never attempt any maintenance function that is not specifically described in this documentation.

- Never remove covers or guards that are fastened with screws. There are no operator serviceable areas within these covers.
- Never locate the machine near a radiator or any other heat source.
- Never override or “cheat” any of the electrical or mechanical interlock devices.
- Never place this equipment where people might step on or trip on the power cord.

 **Caution: This device is not intended for use in the direct field of view at visual display workplaces. To avoid incommoding reflections at visual display workplaces this device must not be placed in the direct field of view.**

Electrical Information

WARNING - ELECTRICAL SAFETY INFORMATION

1. The power receptacle for the machine must meet the requirements stated on the data plate on the rear of the machine. If you are not sure that your electrical supply meets the requirements, please consult your local power company or an electrician for advice.
2. The socket outlet shall be installed near the equipment and shall be easily accessible.
3. Use the power cable that is supplied with your machine. Do not use an extension cord or remove or modify the power cord plug.
4. Plug the power cable directly into a correctly grounded electrical outlet. If you are not sure whether or not an outlet is correctly grounded, consult an electrician.
5. Do not use an adapter to connect any Xerox® equipment to an electrical outlet that lacks a ground connection terminal.
6. Do not place this equipment where people might step or trip on the power cable.
7. Do not place objects on the power cable.
8. Do not override or disable electrical or mechanical interlock devices.
9. Do not push objects into slots or openings on the machine. Electrical shock or fire may result.

ELECTRICAL SUPPLY

- This product shall be operated from the type of electrical supply indicated on the product's data plate label. If you are not sure that your electrical supply meets the requirements, please consult your local power company for advice.



- Always connect equipment to a correctly grounded power outlet. If in doubt, have the outlet checked by a qualified electrician.

 **WARNING! This equipment must be connected to a protective earth circuit. This equipment is supplied with a plug that has a protective earth pin. This plug will only fit into**

an earthed electrical outlet. This is a safety feature. If you are unable to insert the plug into the outlet, contact your electrician to replace the outlet.

DISCONNECT DEVICE

The power cable is the disconnect device for this equipment. It is attached to the side of the machine as a plug-in device. To remove all electrical power from the equipment, disconnect the power cable(s) from the electrical outlet.

Emergency Power Off

If any of the following conditions occur, turn off the machine immediately and disconnect the power cable(s) from the electrical outlet(s).

- The equipment emits unusual odors or makes unusual noises.
- The power cable is damaged or frayed.
- A wall panel circuit breaker, fuse, or other safety device has been tripped.
- Liquid is spilled into the machine.
- The machine is exposed to water.
- Any part of the machine is damaged.

Maintenance Information

1. Any operator product maintenance procedures will be described in the user documentation supplied with the product.
2. Do not carry out any maintenance on this product which is not described in the customer documentation.
3. Do not use aerosol cleaners. The use of cleaners that are not approved may cause poor performance of the equipment, and could cause a dangerous condition.
4. Use supplies and cleaning materials only as directed in this manual.
5. Do not remove covers or guards that are fastened with screws. There are no parts behind these covers that you can maintain or service.
6. Do not perform any maintenance procedures unless you have been trained to do them by an authorized local dealer or unless a procedure is specifically described in the user manuals.

Product Safety Certification

This product is certified by the following Agency using the Safety standards listed:

Standard
UL62368-1 (USA)
CSA 22.2 No. 62368-1 (Canada)
IEC 62368-1

Environmental Health and Safety Contacts

Contact Information

For more information on Environment, Health, and Safety in relation to this Xerox® product and supplies, please contact the following customer help lines:

North America & Europe (Phone): 1-800-ASK-XEROX
--

North America & Europe (Fax): 1-585-422-8217

2. Welcome

Your new Xerox® D50 Scanner can quickly scan stacks of documents with the Automatic Document Feeder (ADF), or single pages on the Flatbed glass.

What's in the Box

Before proceeding, check the contents of the box. If items are missing or damaged, contact the dealer where you purchased the scanner.

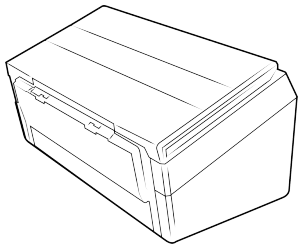

Xerox® D50 Scanner

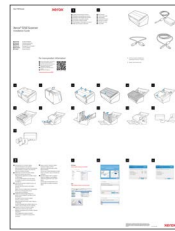

Quick Install Guide

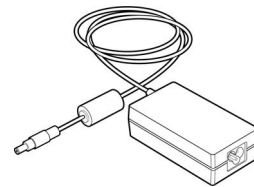

Power Supply

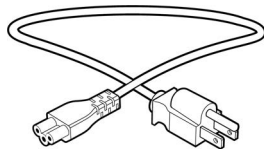

Power cord

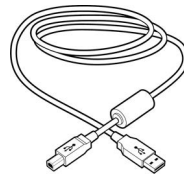

USB Cable

- Technical Support and Warranty Information
- Register Your Scanner Card

System Requirements

- Intel Pentium 4 or equivalent processor
- Universal Serial Bus (USB) 3.0 port
- Apple® Mac OS X® operating system (11-14)
- Microsoft® Windows® operating system:
 - 32-bit or 64-bit Windows 7 (Service Pack 1)
 - 32-bit or 64-bit Windows 10
 - 32-bit or 64-bit Windows 11
- Minimum of 2 gigabyte (GB) of internal memory (RAM)
- Minimum available hard disk space:
 - 350 MB for the scanner driver
 - 1 GB for Visioneer OneTouch
 - 1 to 3 GB for each additional application
- Monitor (recommended settings)

- Color quality of 16-bit or 32-bit
- Resolution set to at least t 800 x 600 pixels

Refer to your Windows documentation for instructions on setting the color quality and resolution for the monitor.

Documentation

The following printed documentation is provided in the box:

- **Installation guide**—abbreviated scanner setup and installation instructions.
- **Technical support card**—contact information for technical support and customer service, and a brief overview of our standard product warranty. Follow the instructions on the card to register your device.

The following soft-copy documentation is available during installation or on www.xeroxscanners.com:

- **Scanner user guide**—instructions for scanner setup, installation, operation, maintenance, safety, and warranty.
- **OneTouch scanning guide**—instructions for configuring and scanning using OneTouch.
- **TWAIN scanning guide**—instructions for accessing and scanning using the TWAIN interface.
- **Patch code sheets**—use with an application that supports detection of patch code data when using the TWAIN interface. The patch code page layouts have been specifically designed for your scanner. The file contains Patch 1 layouts for A4 and U.S. Letter size pages.

Make sure you print the correct page size for the paper in your printer. Also, make sure the application you are using is not set to automatically scale the page to fit on the paper in your printer.

Xerox® D50 Scanner Features

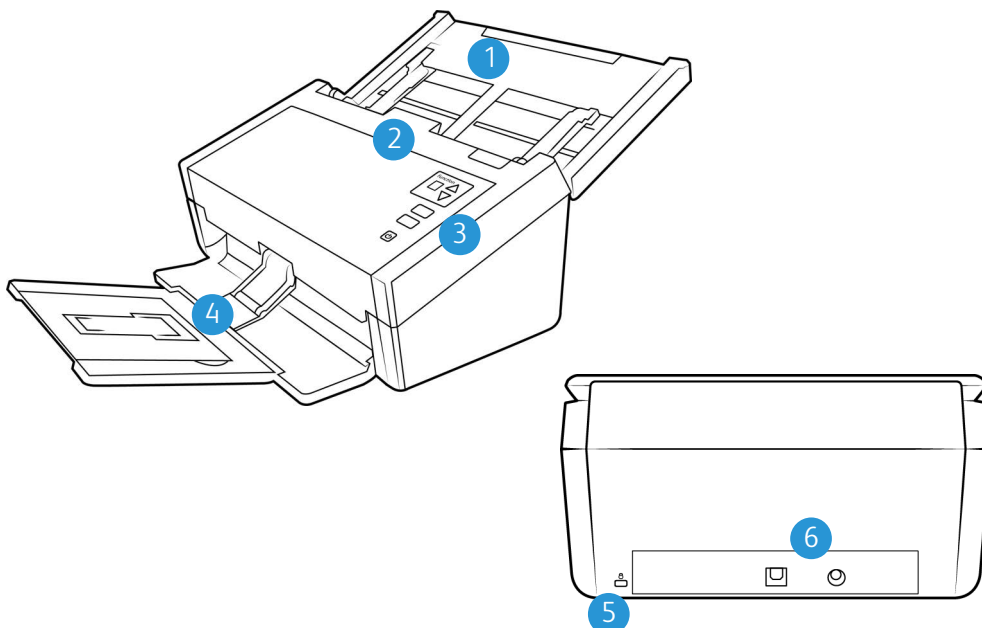

1. **Input Tray**—Holds the documents in the Automatic Document Feeder for scanning.
 - **Extension**—Pull out to support various document lengths.
 - **Paper Guide Switch**—Push up to allow the paper guides to adjust wider for dot matrix printer paper.
 - **Paper Guides**—Slide to adjust to document width.
2. **Automatic Document Feeder**—Feeds documents through the scanner during scanning.
 - **ADF Cover Release**—Press to open the Automatic Document Feeder.
3. **Control Panel**—OneTouch scanning controls.
 - **Function Buttons**—Select the scan setting for the OneTouch buttons. Press the up or down arrow to cycle through the settings.
 - **Cancel Button**—Press to cancel any process the device is undergoing.
 - **Scan Button**—Press to scan the documents.
 - **Status Light / Power Button**—Turns the scanner's power on/off and indicates the scanner's status.
4. **Output Tray**—Holds documents after being scanned.
 - **Paper Stop (Short Documents)**—Flip up to keep short items stacked neatly in the output tray after scanning. Slide to adjust to the length of the scanned documents.
 - **Extension**—Flip out to support various document lengths.
 - **Paper Stop (Regular Documents)**—Flip up to keep regular documents stacked neatly in the output tray after scanning.
5. **Safety Lock Slot**—Connect a Kensington® style safety lock.
6. **Connections**—Scanner connection ports.
 - **Universal Serial Bus (USB) Port**—Connect the scanner to the computer via the USB 3.0 cable.
 - **Power Jack**—Connect the power cord to the scanner.

3. Assemble the Scanner

Unpacking the Xerox® D50 Scanner

1. Remove the scanner from its protective foam and plastic bag.
2. Remove any shipping tape from the scanner as indicated in the following illustration(s).

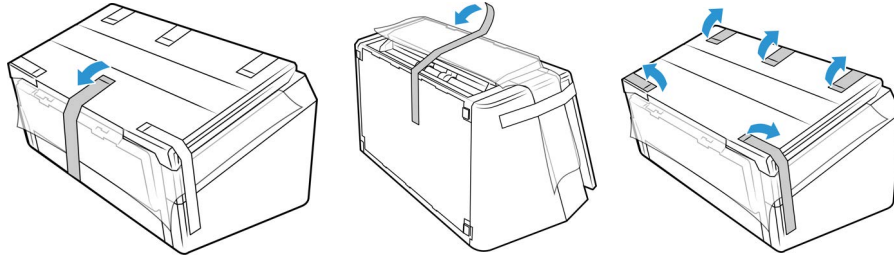

3. Lift the input tray up from the scanner. Pull the output tray down from the scanner body. Remove any shipping tape from the input and output trays.

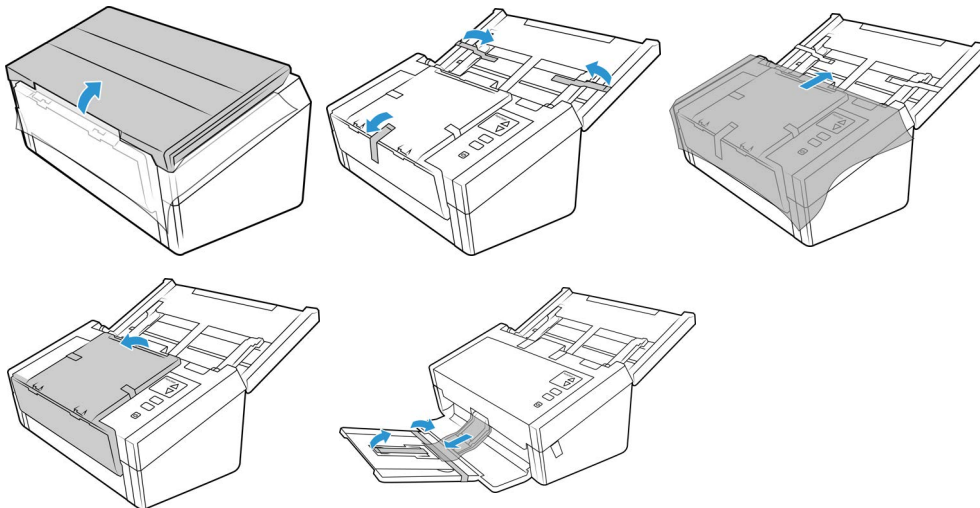

4. Open the automatic document feeder cover and remove any tape or protective foam from inside the feeder. Close the feeder cover when you are finished.

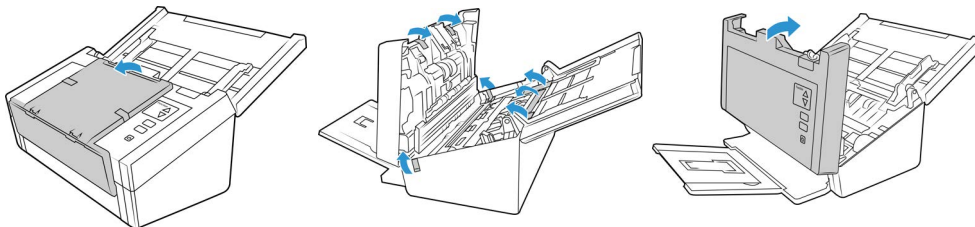

5. Slide the release switch in the output tray if you want it to lay flat on the desk.

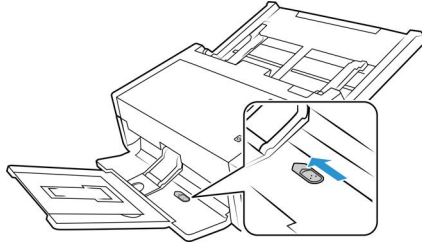

Connect the Power Cord

Note: Only use the power supply (DA-48M24 made by APD) included with your scanner. Connecting any other type of power supply may damage your scanner, and will void its warranty.

1. Plug the power supply into the power port on the scanner.
2. Plug the power cord into the power supply and into a wall outlet.

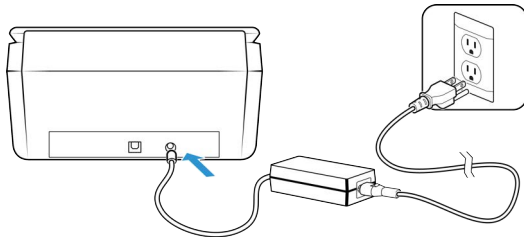

Connect the USB Cable

1. Plug the round end of the USB cable into USB port on the device.
2. Plug the flat end of the USB cable into an available USB port on the back of the computer.

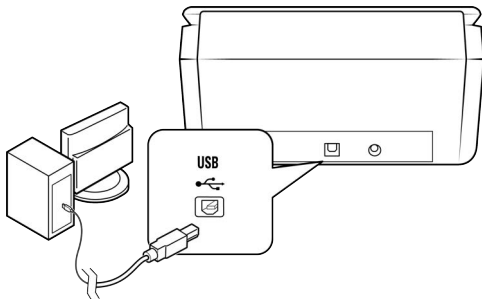

Note: Only use the USB power cable included with your device. Connecting any other type of USB power cable may damage your device and will void its warranty. If you do not have your USB power cable, you can order a new one by contacting our customer service department. Please refer to the Technical Support Card that you have received with your device for our company contact information or visit the Parts & Accessories page for your device at www.xeroxscanners.com.

Safety Lock

Your scanner may have a slot for installing a Kensington® style safety lock. This slot can be identified by the lock icon. It is to the left of the USB port on the scanner. When following the instructions in this document, make sure you connect the USB cable into the USB port which is identified by the USB symbol.

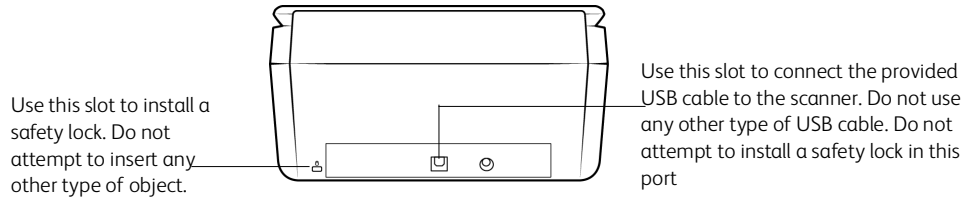

A lock is not provided with the scanner and this document does not contain instructions on purchasing and installing a safety lock. If you choose to use a safety lock, please carefully read the installation instructions provided with the lock. More information about Kensington® locks can be found at www.kensington.com.

4. Installation

Windows

Please make sure of the following before you begin installation:

- If you are prompted to reboot during installation, please select **No**. Finish installing the rest of the software, then close all open windows and reboot your computer.
- The information in this guide may cover software not provided with the scanner you purchased. Please disregard any information about the software not applicable to your scanner.
- If your computer has AntiVirus or AntiSpyware software running, you may encounter alerts or messages during installation asking you to allow the installation to proceed. Although the messages will differ based on the software your computer is running, in each case you should allow the installation to proceed if that option is available. Alternatively, you can turn off the AntiVirus or AntiSpyware software before installing your scanner, but if you do, make sure to turn it back on again when installation is finished.
- If your computer is running Windows 7 or later, you may see the Windows User Account Control screen asking you to confirm system changes. Click the **Yes** button to allow the installation to proceed.

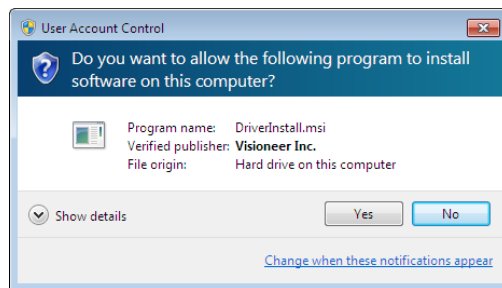

USB DRIVER INSTALLATION

Follow these steps to install the driver to use the scanner via a USB connection to your PC. This allows only the logged in user to use the scanner.

1. Start Microsoft Windows and make sure that no other applications are running.
2. Turn on the scanner power.
3. Plug the USB cable into the USB port on the scanner then into a USB port on the computer.
4. Go to www.visioneer.com/install
5. Launch the installer, once the download is complete.

- Click **OK**.

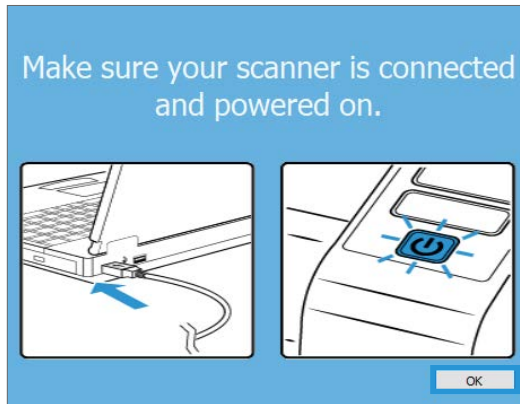

- Select your scanner from the list. Click **Proceed**.

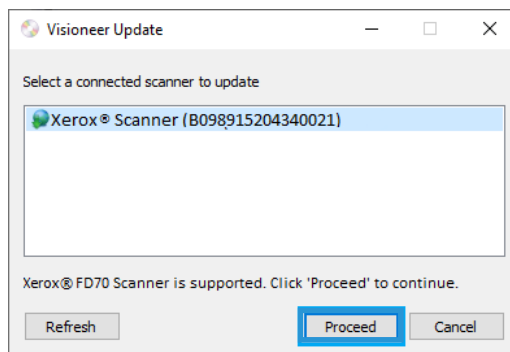

- The Select Language window opens. Click the drop-down menu arrow and select the language to use. Click **OK**.

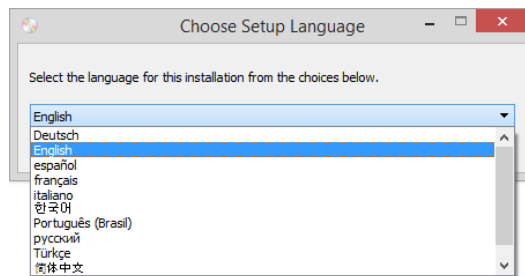

9. Make sure the boxes for **Scanner Driver** and **Visioneer OneTouch** are selected, as well as any other applications you want to install.

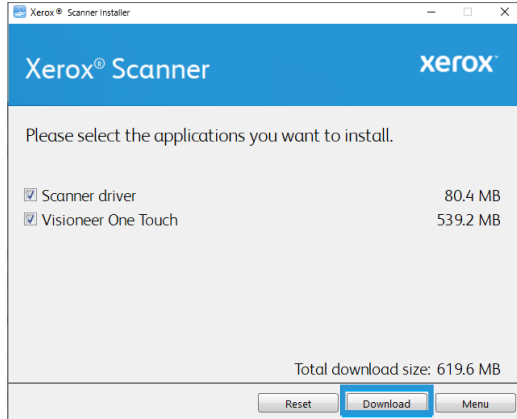

The software will have to first be downloaded by clicking **Download**. The total size of the download is shown at the bottom.

10. After the download has begun, it can be paused. If changes to the selections are required, it is necessary to click **Reset** while the download is paused. This will allow the settings to be changed.

Note: Clicking the Reset button in either the Main menu or the Install menu will cause both partially completed and previously downloaded files to be deleted. In order to be installed they will have to be downloaded again.

11. Once all software has been downloaded, click **Install**.

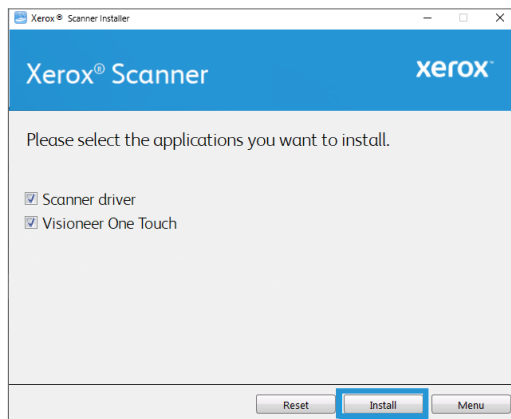

- On the License Agreement windows, read the license agreements. If you accept the terms, select **I Agree**.

If you click **I do not agree**, the installation will terminate.

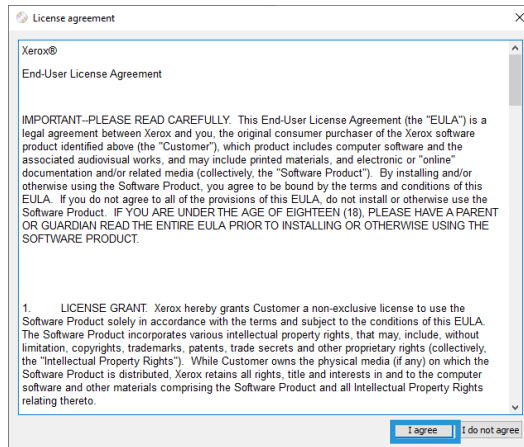

- Once all of the software has been installed, Click **Exit**.

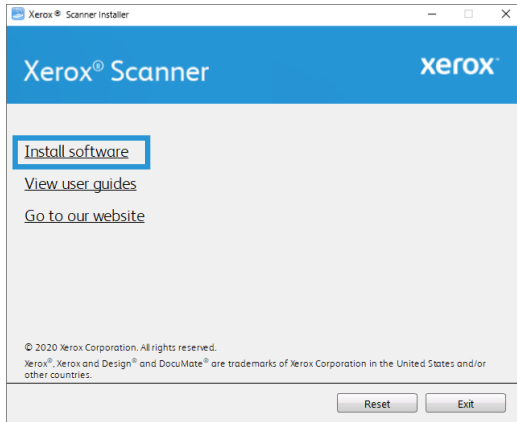

Mac

- Start Microsoft Windows and make sure that no other applications are running.
- Turn on the scanner power.
- Plug the USB cable into the USB port on the scanner then into a USB port on the computer.
- Go to www.visioneer.com/macinstall
- Launch the installer once the download is complete.

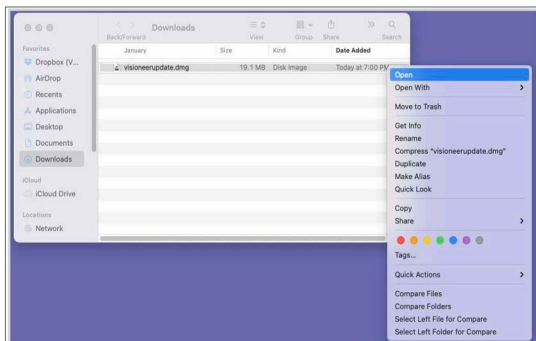

- Double-click the VisioneerUpdate disc icon.

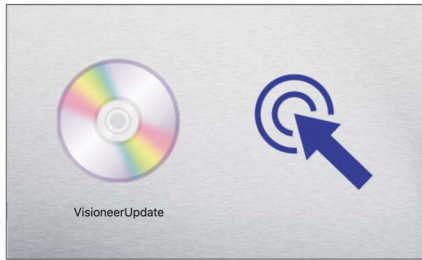

- Click **OK**.

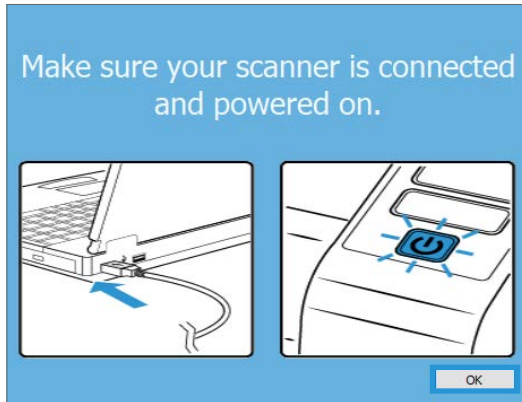

- Select your scanner from the list. Click **Proceed**.

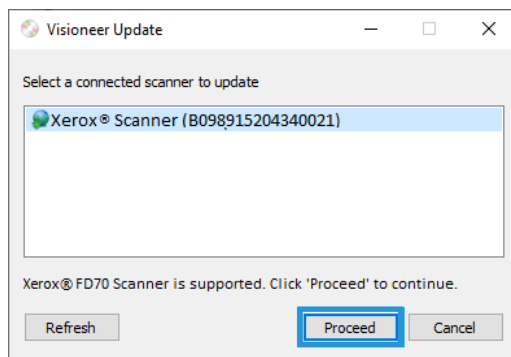

- The Select Language window opens. Click the drop-down menu arrow and select the language to use. Click **OK**.

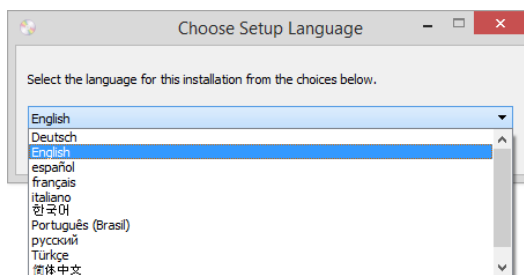

10. Make sure the boxes for **Scanner Driver** and **Visioneer Scan Utility** are selected, as well as any other applications you want to install.

Visioneer Scan Utility — This utility uses the scanner's TWAIN interface for scanning. You can select a destination folder on your computer and save the image as any one of several popular image file formats (BMP, JPG, GIF, TIF, Multi-Page TIF, PDF, Multi-Page PDF).

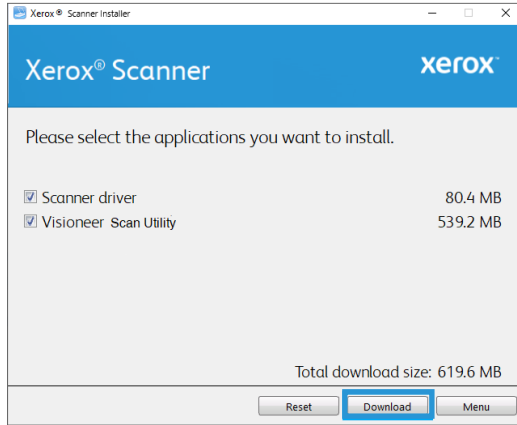

The software will have to first be downloaded by clicking **Download**. The total size of the download is shown at the bottom.

11. After the download has begun, it can be paused. If changes to the selections are required, it is necessary to click **Reset** while the download is paused. This will allow the settings to be changed.

Note: Clicking the Reset button in either the Main menu or the Install menu will cause both partially completed and previously downloaded files to be deleted. In order to be installed they will have to be downloaded again.

12. Once all software has been downloaded, click **Install**.

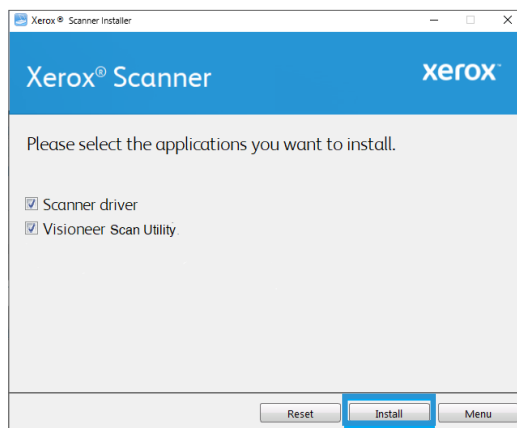

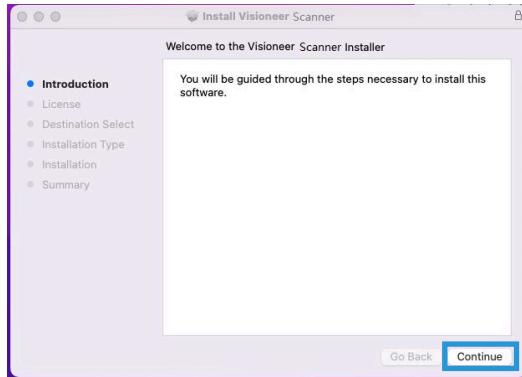
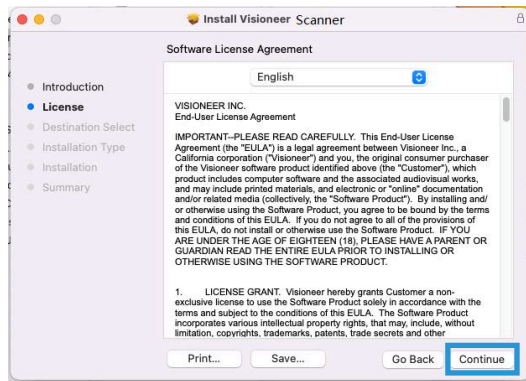
13. Click **Continue**.14. On the License Agreement window, read the license agreement and click **Continue**.15. If you accept the terms, select **Agree** and continue with the installation.

If you choose not to accept the license agreement, close the installation window. The scanner driver will not be installed.

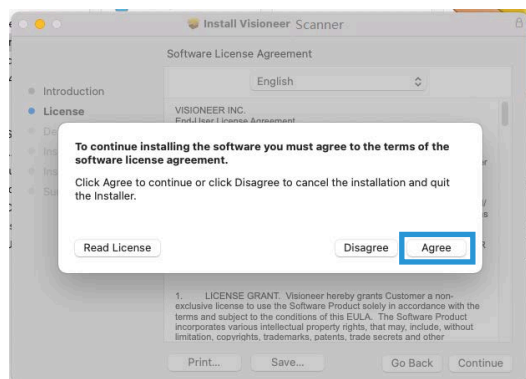

16. Depending on your system configuration, you may be prompted to choose a location for the installation. We recommend that you select the main disc drive and click **Install**.

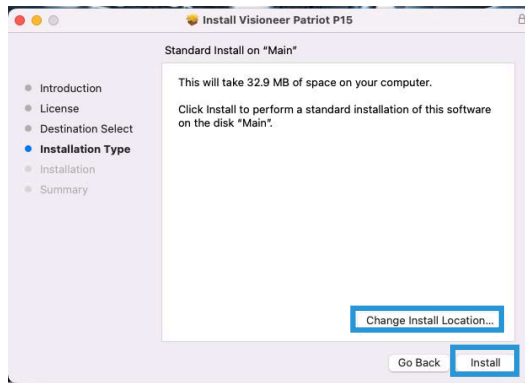

17. If you are prompted for a password, input the name and password for a user that has permission to install software on your computer.



18. Click **Close** on the installation complete window.

You can now connect the scanner to your computer.

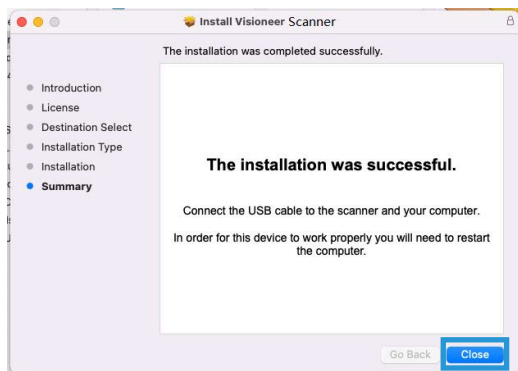

Installing Additional Applications

1. Once all of the software has been installed, click on Install software.

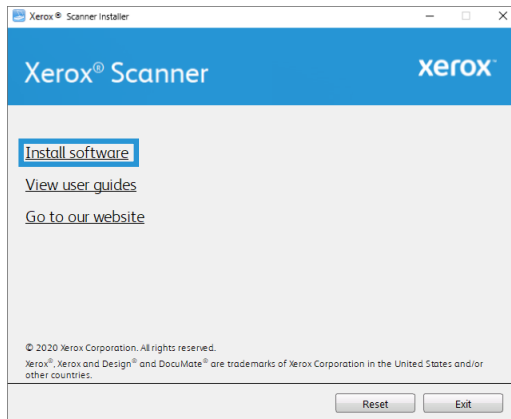

2. If a version of the software is already installed on the system, the option will be greyed out. However, if there is a newer version available, it will be possible to download and install.
3. The software will have to first be downloaded by clicking **Download**.
4. Once all software has been downloaded, click **Install**.
5. Follow the instructions on the screen to install each of the additional applications.

View the User Guides

1. Once all of the software has been installed, click on View user guides from the Main menu.

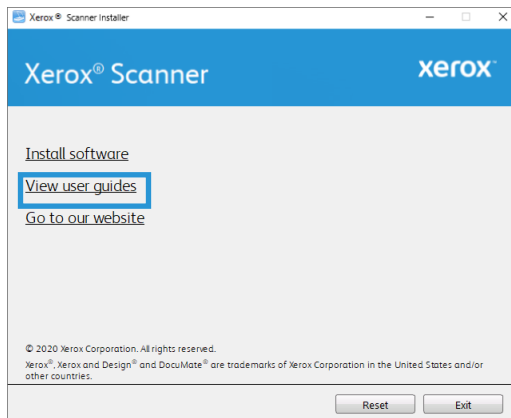

2. Click on **View scanner documentation** to access the scanner user guide and scanning guides for OneTouch and TWAIN.

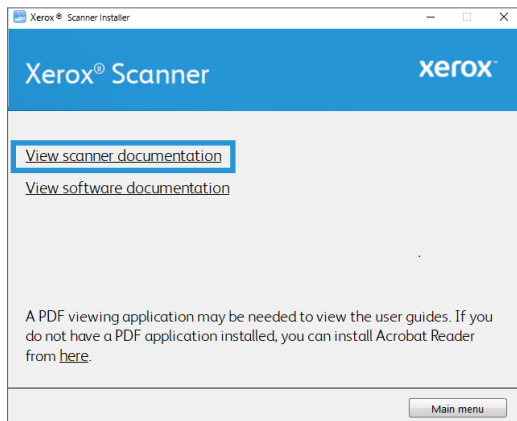

3. Click the links of the guides you want to view.

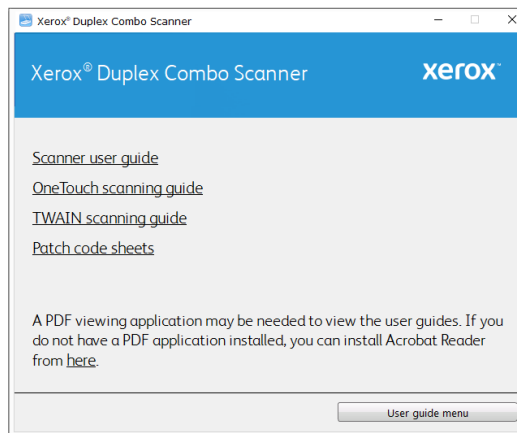

4. Click on the **User guide menu** button to return to the main user guide window, then select the other documentation section to view the user guides.
5. When you're finished, click **Main menu** to return to the Main menu window and click **Exit**.

Register Your Scanner

Registering your scanner is important as it provides you with access to our free telephone support service. Registration also gives you free access to software updates for your scanner.

You will need an active internet connection to register your scanner. If you do not have internet access you can contact our customer service department to register the scanner. Please refer to the Technical Support Card, that you received with the scanner, for our customer service contact information.

1. Open an Internet Explorer window, or any other Internet browser you have installed on your computer.
2. In the web address field type www.xeroxscanners.com.
3. Press Enter on your computer's keyboard or click the option on screen to go to the web address.
4. When the Xerox® scanners web page loads click on **Register Your Product**.

5. Fill in the registration form, all required fields have an asterisk (*).
A valid email address is required for registration.
6. You will be asked to enter the serial number for the scanner, it is located on the back or underside of the scanner.
7. After filling in the form, click on **Submit Your Registration** to complete the registration.

5. Loading Documents to Scan

Always remove any staples or paper clips from documents before inserting them into the scanner. Staples and paper clips can jam the feed mechanism and scratch the internal components. Also remove any labels, stickers, or Post-It™ notes that may come off during the scanning process and get stuck in the scanner. Misuse as described here will void your scanner's warranty.

Please go to www.xeroxscanners.com, select your product, and then click the “Warranty Program” link to view the warranty terms and conditions for your scanner.

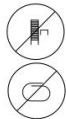

Supported Document Types

You can scan the following types of documents and cards with this scanner.

- Maximum amount of paper in the input tray
 - Approximately 80 pages of 20 lb (75–80 g/m²) new printer paper
- Document size
 - Minimum size (width x length) – 2 x 2 inches (51 x 51 mm)
 - Maximum size (width x length) – 8.5 x 14 inches (216 x 356 mm)
 - Maximum length with long document enabled
 - 118 inches (2997 mm) up to 300 dpi
 - 59 inches (1499 mm) at 400 dpi and higher

We recommend scanning one page at a time when the documents you are scanning are longer than 14 inches (356 mm).

- Mixed document stacks
 - Scanner minimum to maximum without long document enabled

Arrange the documents so that all items are centered in the stack. The document sensor, paper separation, and feed rollers are located in the middle of the paper path. If smaller items are offset from the center they will not be detected. This will cause feeding issues and paper jams.
- Dot matrix printer paper
- Paper thickness between 7–110 lb paper (27–413 g/m²)
- Embossed plastic cards up to 1.25 mm thick
- Non-embossed plastic cards up to 1 mm thick

Documents to Avoid Scanning

The documents in this list can be scanned, but please note that scanning documents of this type will reduce the life of the scanner. Maintenance will be required more often and replaceable parts will wear faster. These types of documents will jam more frequently and damage to the original documents may occur. If you do choose to scan these document types, do not scan large batches. This type of use is not covered under the scanner warranty and alters replacement parts life expectancy.

We recommend you limit the amount or completely avoid scanning documents that are in this list.

- Curled, wrinkled or folded documents may cause paper jams or multiple pages being fed through the scanner at one time.
- Perforated or punched paper that could tear when the separation roller engages.
- Coated paper or photographs where the coating can flake off during scanning and leave residue in the scanner.
- Extremely smooth, shiny, or highly textured paper may cause the paper feed rollers to slip across the page and cause the scanner to report a paper jam.
- Carbonless copy paper may tear while being fed through the scanner and the pressure of the rollers may leave streaks on the page. The chemical coating on this paper will rub off on the rollers during the scan process, increasing the frequency of miss-feeds and paper jams.
- Partially transparent paper such as tracing paper as any images from the opposite side of the page or black background will appear in the scanned images.

Unsupported Document Types

Do not scan the following types of documents as they may cause damage to the scanner.

- Items outside of the specified supported sizes, thickness, and weight defined in this document.
- Non-rectangular or irregularly shaped paper will cause the scanner to detect and report document skew errors or paper jams.
- Carbon paper that will leave residue in the scanner and on the rollers that will transfer to the next set of documents scanned.
- Documents with hard items attached such as paper clips, binder clips, and staples.
- Documents with wet ink or white-out.
- Thermal or photosensitive paper.
- Overhead projector sheets, plastic film, camera film, and any other type of transparent or partially transparent plastic item.
- Documents that have been glued together.
- Cloth or metallic sheets.

Scanning from the Automatic Document Feeder (ADF)

SCANNING REGULAR DOCUMENTS

Make sure the paper guide switch is in the correct position for scanning regular documents, as indicated in the following illustration.

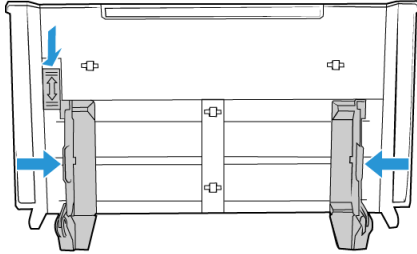

When the paper guide switch is in the down position, the paper guides can be adjusted to a maximum of 8.5 inches (216 mm) wide. If the paper guides are adjusted wider than the maximum for regular paper, documents may skew excessively during scanning.

Preparing Documents for Scanning

- Fan the documents to make sure all pages in the stack are separated.
- Bend and then flatten the document stack to make sure the horizontal edges are aligned to help prevent paper from skewing while being pulled through the scanner.
- Pinch the ends to align the leading edges slantwise to help prevent multiple pages from being fed through at a single time.

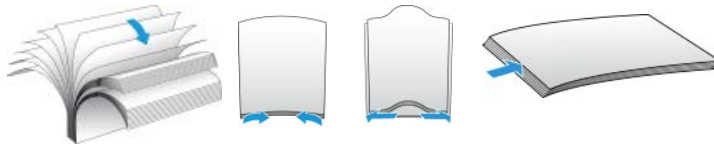

Loading Documents

1. Make sure the paper guide switch is in the down position.
2. Flip up the paper guides and adjust them to the width of the documents you are scanning. Extend the input and output trays.

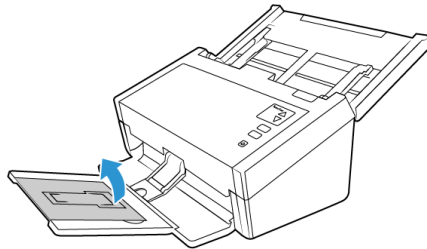

3. Load the documents *face up* with their tops into the Automatic Document Feeder.

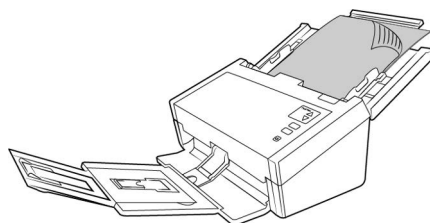

- You can now scan the documents using the scanner buttons, OneTouch, or one of the other scanning interfaces.

Note: Occasionally the last page in a scanned batch may not be ejected completely. To resolve this, raise the paperweight and release the output tray to lie flat as shown.

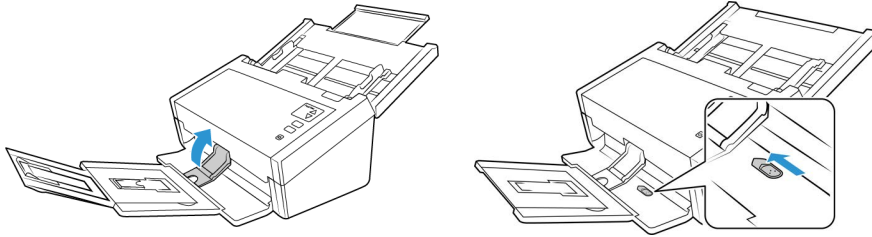

SCANNING DOT MATRIX PRINTER PAPER

With the Xerox® D50 Scanner you can scan dot matrix printer paper without removing the perforated sides from the page.

- Separate the pages so that you have a stack of single pages.

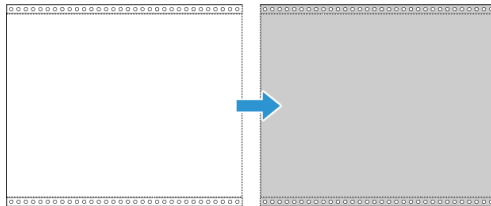

Do not place a stack of connected paper in the input tray. The paper will tear when the separation roller attempts to separate the current page from the rest of the stack. If you want to scan a long document of dot matrix paper, try placing the document stack on the desk behind the input tray. Close the input tray extension and place the leading page in the input tray.

- Slide the paper guide switch up and then adjust the paper guides.

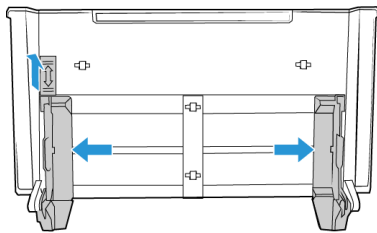

- Flip up the paper guides, extend the input and output trays.

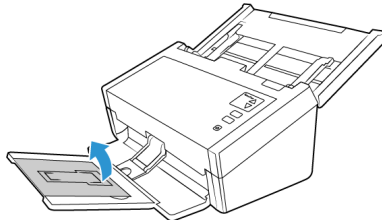

4. Load the documents face down with their tops into the Automatic Document Feeder.

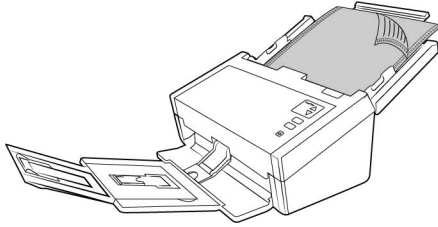

5. You can now scan the documents using the scanner buttons, OneTouch, or one of the other scanning interfaces.

Scanning Interfaces

WINDOWS

- **Scanner Control Panel**—When you press the Scan button, the scanner starts scanning using the settings for the current LED number. The scanned image is then sent to a destination on your computer or network drive.

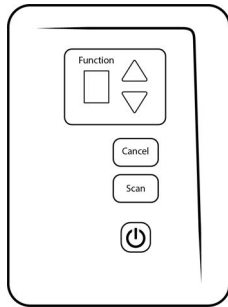

Scanner Control Panel

- **OneTouch Button Panel**—Use this scan option when you want to scan from the computer screen. Scanning from the on-screen OneTouch Button Panel is the same as selecting a scanning option on the scanner, except you click an icon that represents the function.

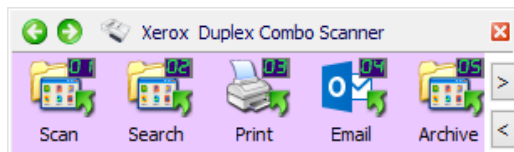

OneTouch Button Panel

Please see the OneTouch Scanning Guide on www.xeroxscanners.com for instructions. You can also click the **Help** button in the OneTouch Properties window to open the instructions in an Internet browser.

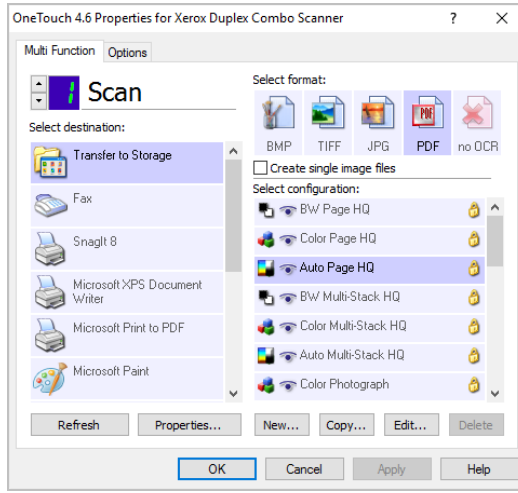

- **TWAIN and WIA Interface**—this option uses your scanner's TWAIN interface to scan. Select scanning options before scanning, put the document in the scanner, then click the **Scan** button in the TWAIN interface window.

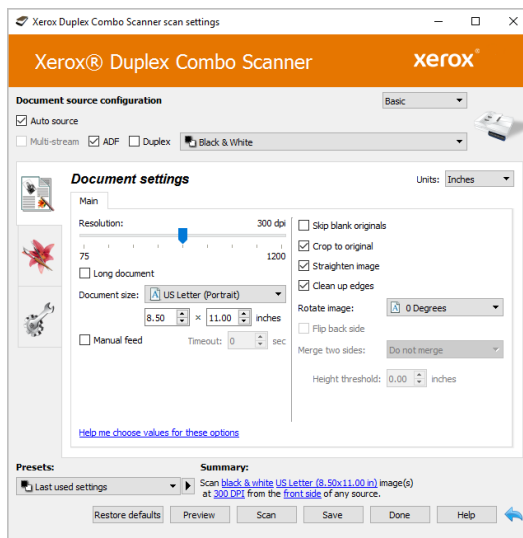

Please see the TWAIN Scanning Guide on www.xeroxscanners.com for instructions. You can also click the **Help** button in the TWAIN interface to open the instructions in an Internet browser.

- **ISIS Interface**—This option uses the ISIS interface for scanning. Please refer the user manual for your ISIS scanning application for instructions on scanning with the ISIS interface.

MAC

Every scanning application will access the scanner using a different method. Please refer to the application's user guide for instructions on using the application and accessing the scanner.

- **TWAIN Interface** — TWAIN is a widely recognized standard that computers use to receive images from scanners and digital cameras. The TWAIN scanning interface can be accessed from any TWAIN scanning application you have installed on the computer.

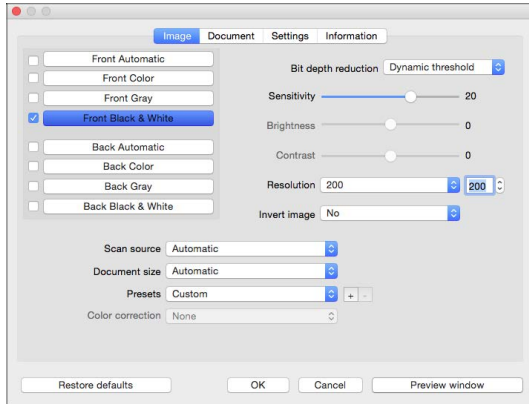

- **ICA Interface** — the ICA driver has been developed to enable image transfer from devices using standard Mac applications, such as Image Capture, without the need to install additional scanning software.

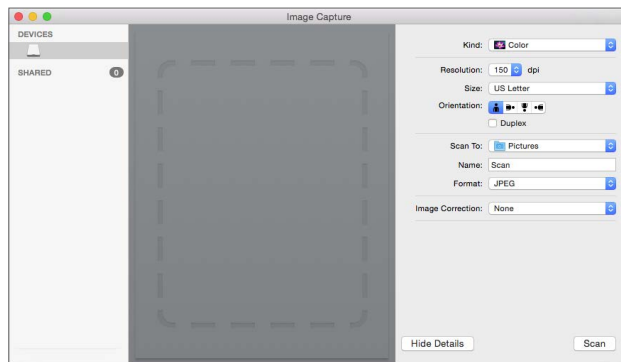

6. Maintenance

This section contains information about maintenance, troubleshooting, uninstalling, scanner specifications, and spare parts.

Safety Precautions

When servicing the scanner you should take the following precautions to ensure your safety and prevent damage to the scanner.

Do These

- Wear protective gloves when cleaning the scanner with Isopropyl rubbing alcohol. Rubbing alcohol may irritate sensitive skin.
- Only perform scanner maintenance as described in this chapter.
- Keep the scanner and cleaning supplies away from any open flame or heat source as any form of alcohol is flammable.
- Always read the instructions in each section carefully, the instructions are specific to the part you are installing or servicing.
- Move the scanner to an area that has adequate room for opening the scanner.
- If your scanner has a power cord and/or power switch, always turn off the scanner and unplug the power cord before performing maintenance, unless the maintenance instructions below specifically state to leave the scanner plugged in and powered on.
- Always unplug the USB cable from the scanner before performing maintenance, unless the maintenance instructions below specifically state to leave the scanner plugged in.
- Wear an anti-static strap to prevent electrostatic discharge when touching metal components.
- Keep all cleaning supplies, scanner parts and accessories out of the reach of children.

Do Not Do These

- Never attempt installation of any part not described in this manual.
- Never service the scanner near a radiator or any other heat source.
- Never use aerosol sprays or compressed air, or attempt to lubricate parts with an oil or silicon spray.
- Never service the scanner in an area where there are open liquid containers.
- Never pour or spill liquid on the scanner or any of its components.

Hardware Properties

You can use the scanner's properties page to keep track of scanner maintenance, change some of the hardware options, configure the scanner interface behavior, and adjust application options that may be available for your scanner.

WINDOWS

To open the scanner hardware properties page:

- **Windows 7** or later—from the Windows Control Panel, open **Hardware and Sound** and then **Devices and Printers**. Right-click on the scanner and then select **Scan properties** from the list.

Device Settings

The Device Settings tab shows the hardware information for your scanner. The options on the Device Settings tab will be available based on whether or not the scanner hardware supports the feature. Some features described herein may not be available for the current scanner. Please disregard any information about features that you do not see in the interface for your scanner.

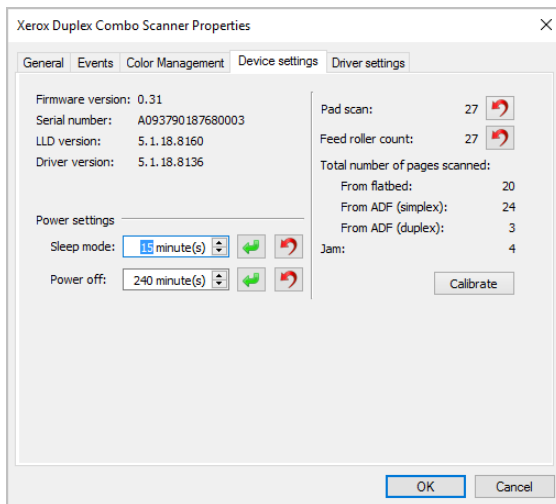

- **Scanner Details:**
 - **Firmware version**—this is the scanner’s hardware processor version number.
 - **Serial number**—the scanner’s unique identification number.
 - **LLD version**—the scanner’s base driver version. This is not the OneTouch software revision, TWAIN or WIA driver versions.
 - **Driver version**—this is the version of the scanner’s TWAIN driver.
- **Scanner Settings:**
 - **Counters**—click the reset button next to the counter you want to set back to 0.
- **Power Settings:**
 - **Sleep mode**—sleep mode is the low-power state when the scanner is not in use. You can adjust the amount of time you want the scanner to wait before it goes into low power.
 - Click the **green enter** button to save any changes in the Sleep mode field.
 - Click the **red reset** button to reset to the default timeout value.
 - **Power off**—input the number of minutes you want the scanner to wait before it turns itself off.
 - Click the **green enter** button to save any changes in the power off field.
 - Click the **red reset** button to reset to the default timeout value.

Driver Settings

The options in this panel are for configuring how the TWAIN interface will behave in some scenarios. Please see the TWAIN Scanning Guide on www.xeroxscanners.com for instructions.

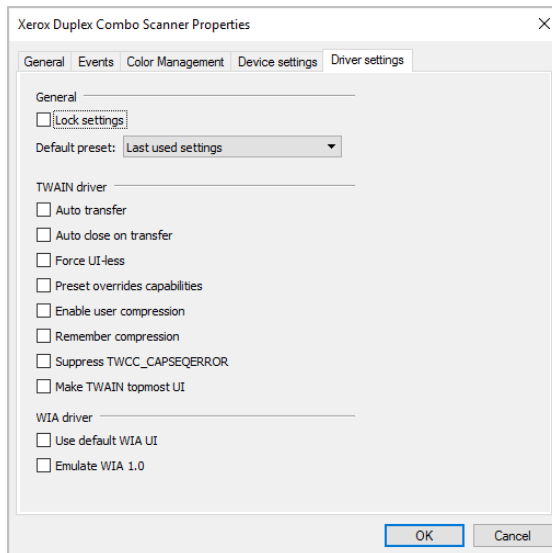

MAC

The Visioneer Scan Utility

In addition to the scanner's interface, you can customize the scanner settings using the Visioneer Scan Utility, explained in the TWAIN Scanning Guide.

Note: On our website, please refer to the TWAIN Scanning Guide provided for your device: www.xeroxscanners.com

For example, the Information panel shows hardware information for your scanner, including controls for resetting the Roller Count. (Resetting the roller count is typically done after cleaning.)

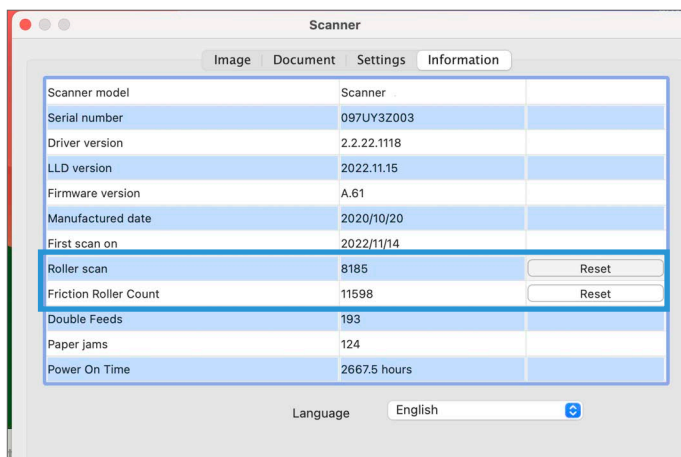

And the Settings panel provides sleep and power off configuration settings.

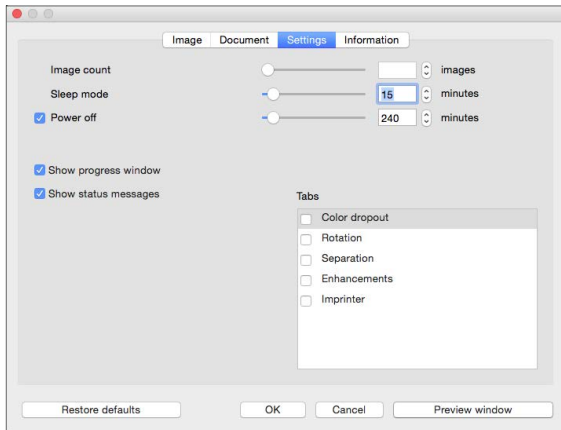

- **Image count** — set the number of images to scan before ending the scan job. When the image count is set to Infinite, it will scan all the pages in the input tray. This number can be adjusted using the slider or by entering a value in the text box.
- **Sleep mode** — sleep mode is the low-power state when the scanner is not in use. You can adjust the amount of time you want the scanner to wait before it goes into low power using the slider or by entering a value in the text box.
- **Power off** — input the number of minutes you want the scanner to wait before it turns itself off. Adjust the value by using the slider or by entering a value in the text box.
- **Show progress window** — select this option to display the progress window of the document(s) during scanning.
- **Show status messages** — select this option to show warning messages on-screen when the scanner rollers or pads have reached the end of their lifespan.

Adjusting the Paper Guides

The paper guides are designed to release from the channel in the scanner body. This prevents damage to the paper guides while performing maintenance or removing the input tray. When following the instructions in this section for troubleshooting and maintaining the scanner, please make sure the paper guides are fully seated before closing the scanner.

Check the position of the paper guides in your scanner compared to the following illustration. If the end of the paper guide is flipped over similar to the image, follow the instructions below for properly seating the paper guides.

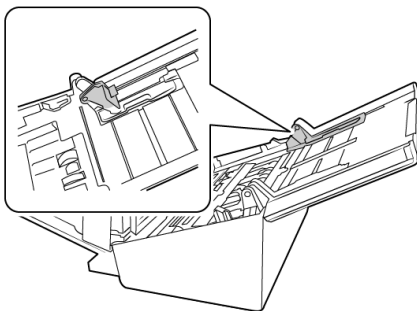

To reset the paper guides:

1. Rotate the end of the paper guide and align the tab with the channel in the scanner.

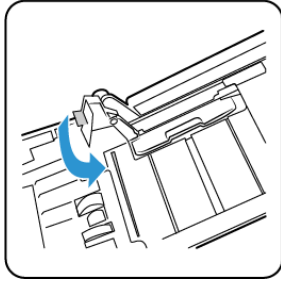

2. Gently press on the paper guide to lock the paper guide in the scanner.

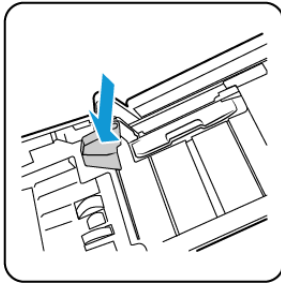

3. You can close the scanner when both paper guides are properly seated in the scanner.

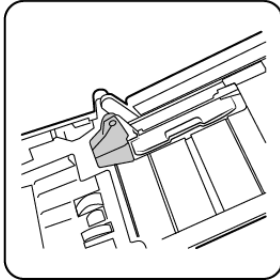

Clearing Paper Jams

If your scanner stops scanning due to a paper jam in the Automatic Document Feeder, a warning opens after a few moments.

1. Open the Automatic Document Feeder cover.

Do not attempt to remove a jammed page with the scanner closed.

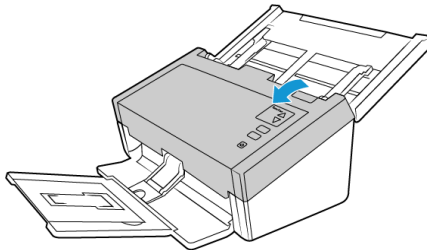

2. Remove the jammed page from the scanner.

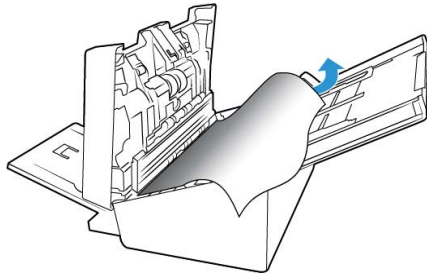

To reduce the number of paper jams, smooth and straighten the paper before scanning, adjust the guides to the paper size, and insert the paper evenly into the ADF.

Cleaning the Scanner

Regular maintenance of your scanner can help to ensure continual optimal performance.

Using a soft, lint-free cloth, wipe down all plastic surfaces on the scanner.

CLEANING INSIDE THE AUTOMATIC DOCUMENT FEEDER

Cleaning the inside of the scanner helps to keep your scanner operating at optimum performance. You should clean the inside of the scanner at least once a week or after 1,000 pages have been scanned. If you are getting frequent paper jams, multiple pages feeding at the same time, or you're seeing lines in the scanned image, it is time to clean the scanner.

Note: Be careful when cleaning the rollers. All of the rollers, except the free rollers, are designed to rotate in one direction only. Do not force the roller to rotate in the opposite direction. Forcing the roller to rotate will damage it, and cause the scanner to feed pages incorrectly.

1. Wet a soft cloth with some Isopropyl rubbing alcohol (70%).
2. Open the Automatic Document Feeder cover.

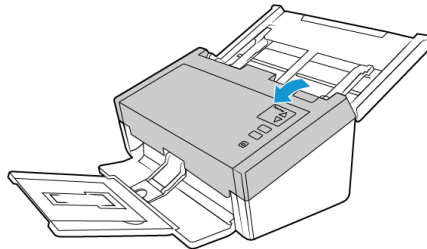

3. Wipe clean the rollers and glass in the scanner body. Rotate the rollers to clean the entire surface.

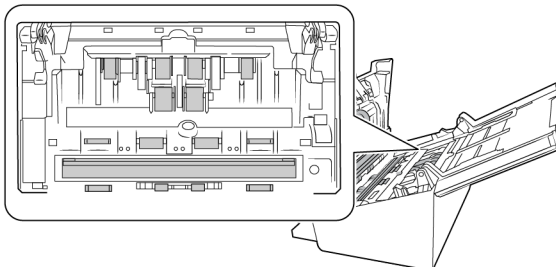

4. Wipe clean the rollers and glass in the underside of the ADF door. Rotate the rollers to clean the entire surface.

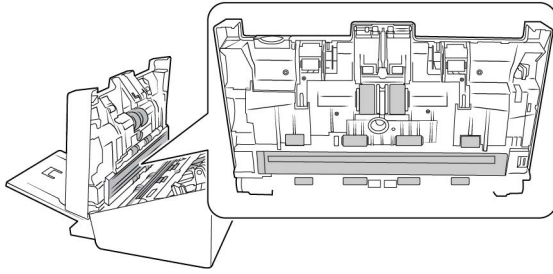

5. Using a clean, dry cotton swab, brush away any dust on the double feed detection sensors.

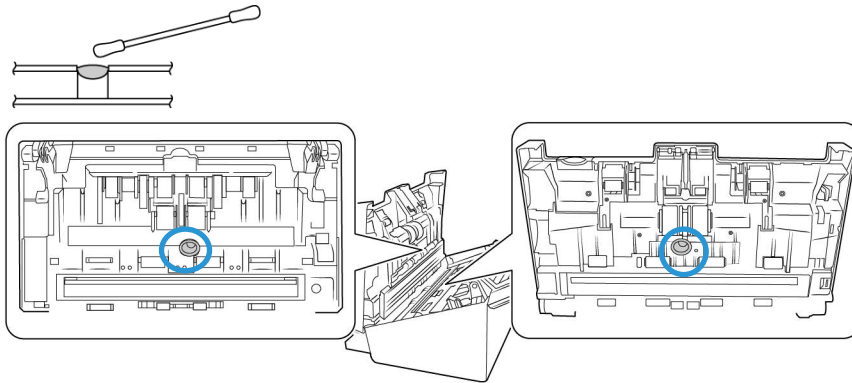

6. Close the scanner when you're finished.

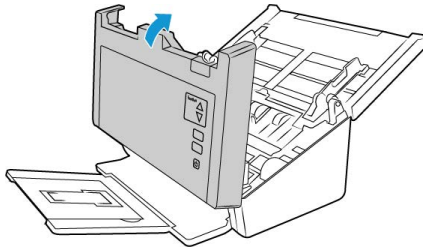

Replacing the Reverse (Separation) Roller

The roller will wear out and is designed to be a user-replaceable part. A worn roller can cause documents to feed in skewed at an angle, or multiple pages to feed at the same time. Before replacing the roller you should clean it as excessive dust on the roller will make it appear worn and smooth. You cannot properly diagnose a worn roller until you have cleaned it. You should generally replace the roller between 80,000 and 100,000 scans.

Replacement parts can be purchased from the Parts & Accessories page for your scanner at www.xeroxscanners.com.

Depending on your hardware, the roller may be slightly different but the steps to replace should be the same.

Scanner Part number 85-0325-### and higher



Scanner Part number 85-0339-### and higher



1. Open the scanner.

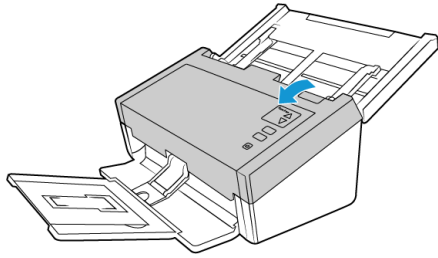

2. Locate the roller cover in the ADF door.

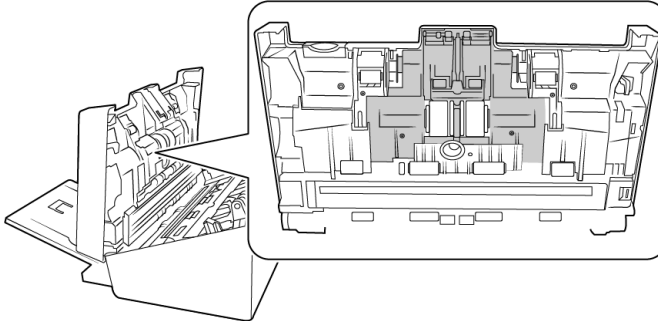

3. Pinch the sides of the roller cover and pull it down to access the roller.

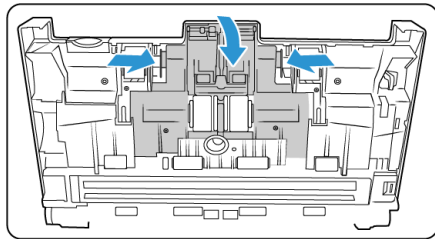

4. Carefully angle the roller up and out of the scanner.

Scanner Part number 85-0325-### and higher

Scanner Part number 85-0339-### and higher

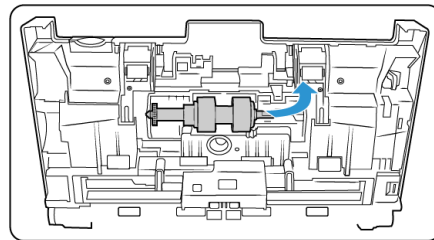
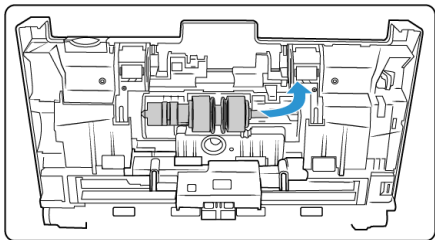

5. Remove the replaceable roller from the bar.

Scanner Part number 85-0325-### and higher

Scanner Part number 85-0339-### and higher

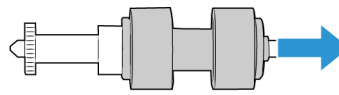
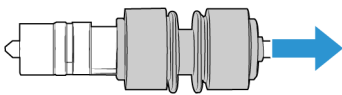

6. Discard the roller, it cannot be repaired or reused.
7. Take the new roller out of its packaging. Clean any dust off the roller before installing it.

- Slide the new roller onto the bar. Make sure the struts on the bar line up to the slots in the end of the roller.

Scanner Part number 85-0325-### and higher

Scanner Part number 85-0339-### and higher

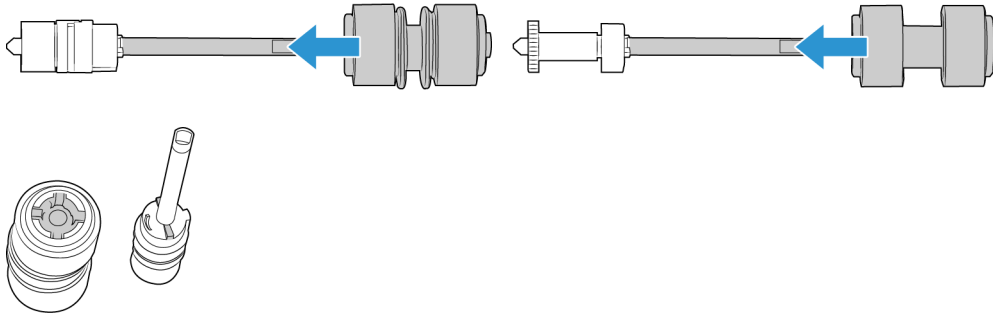

- Insert the round end of the roller into the slot in the scanner. Carefully lower the roller into the scanner. Make sure the groove on the right side of the roller is aligned so that it slides in place into the U-shape of the bracket.

Scanner Part number 85-0325-### and higher

Scanner Part number 85-0339-### and higher

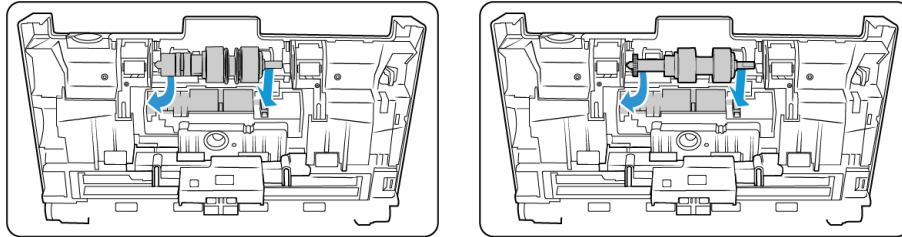

- Lift the roller cover and carefully push it closed to lock it in place. Make sure everything is aligned properly and the cover is fully closed. If the cover is not fully closed it will break during scanning and damage the scanner.

Scanner Part number 85-0325-### and higher

Scanner Part number 85-0339-### and higher

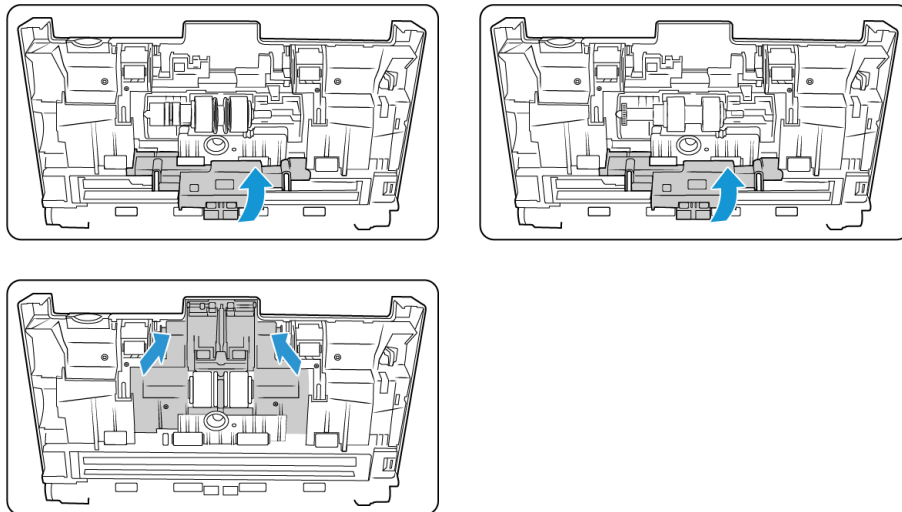

11. Close the scanner when you're finished.

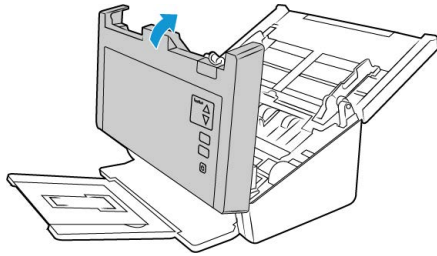

Replacing the ADF (Feed) Roller

The roller will wear out and is designed to be a user-replaceable part. A worn roller can cause documents to feed in skewed at an angle, or multiple pages to feed at the same time. Before replacing the roller you should clean it as excessive dust on the roller will make it appear worn and smooth. You cannot properly diagnose a worn roller until you have cleaned it. You should generally replace the roller every 160,000 to 200,000 scans.

Replacement parts can be purchased from the Parts & Accessories page for your scanner at www.xeroxscanners.com.

Depending on your hardware, the roller may be slightly different but the steps to replace should be the same.

Scanner Part number 85-0325-### and higher

Scanner Part number 85-0339-### and higher

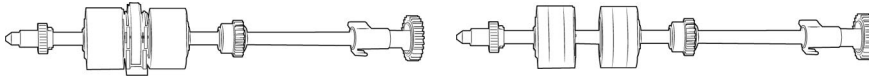

1. Open the Automatic Document Feeder cover.

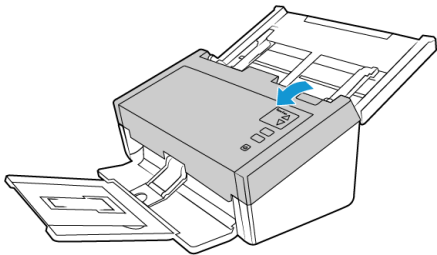

2. Locate the roller cover in the body of the scanner.

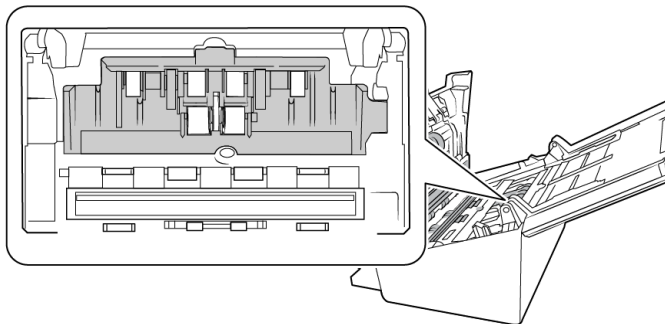

3. Move the paper guides to the side and then pull the feed roller cover away from the scanner.

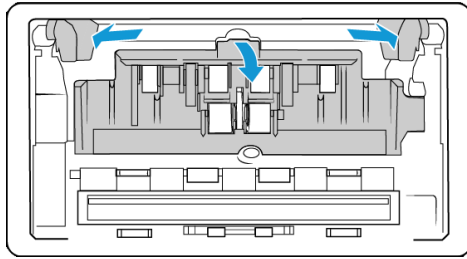

Note: if the paper guides are in front of the roller cover when you open it, they will automatically release from the scanner body. If this happens, see [“Adjusting the Paper Guides”](#) for resetting the guides in the scanner.

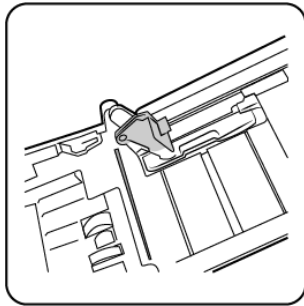

4. For the D50 (Scanner Part number 85-0339-### and higher) only, rotate the belt upwards.

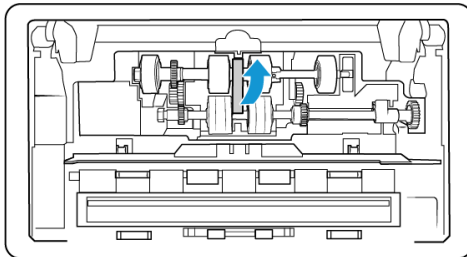

5. The lower roller is held in place with a lock tab that rotates to lock and unlock it. To unlock the tab, rotate it until the small lock flange is completely free.

Scanner Part number 85-0325-### and higher

Scanner Part number 85-0339-### and higher

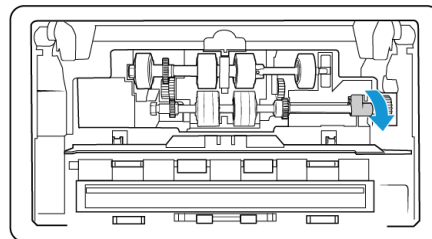
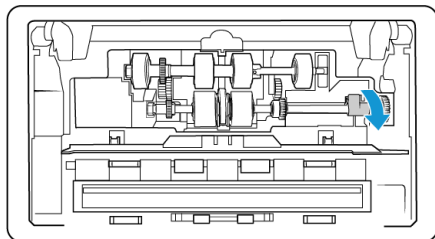

6. Carefully angle the roller up and out of the scanner and then discard it, it cannot be repaired.

Scanner Part number 85-0325-### and higher

Scanner Part number 85-0339-### and higher

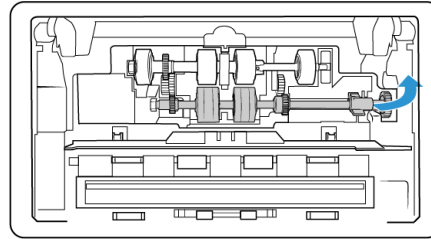
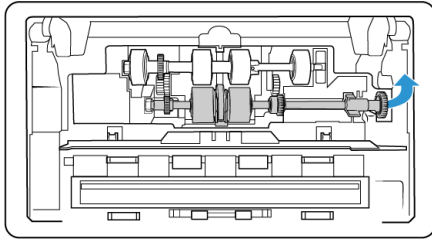

7. Take the new roller out of its packaging. Clean any dust off the roller before installing it.
8. Insert the left end of the new roller assembly into the hole in the roller channel. Angle the roller module into the roller channel. Align the tab on the lock flange with the slot in the scanner.

Make sure the belt on the roller is facing you and that the gears on the roller module properly align to the gears in the scanner. Hold the roller module in the scanner while you lock it in place.

Scanner Part number 85-0325-### and higher

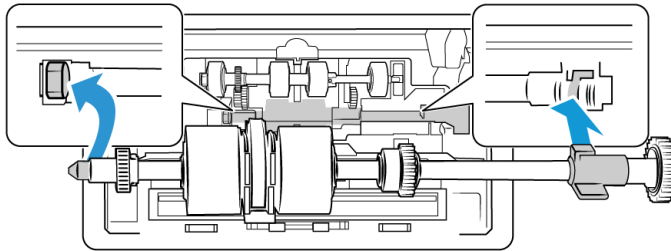

Scanner Part number 85-0339-### and higher

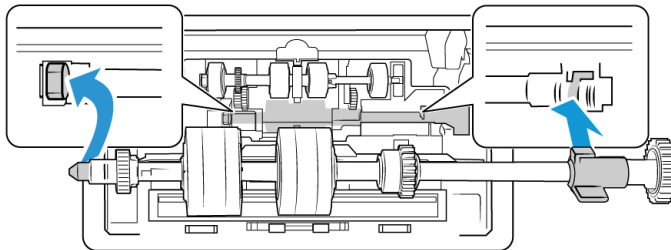

9. Rotate the locking tab into the slot in the scanner. Push on the lever until it clicks in place and locks the roller in the scanner.

The lock will “click” into place when it is secure. However, if it does not rotate easily into the housing, make sure the flange is properly seated in its latch.

Scanner Part number 85-0325-### and higher

Scanner Part number 85-0339-### and higher

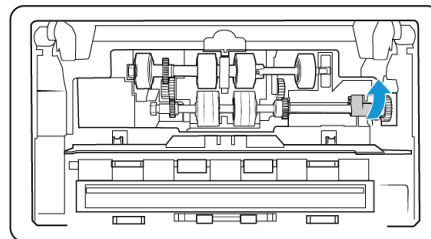
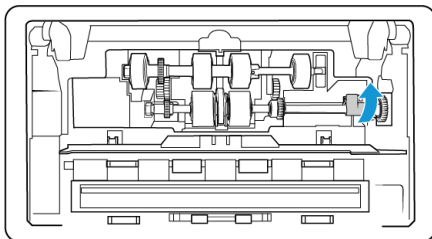

- For the D50 (Scanner Part number 85-0339-### and higher) only, rotate the belt back down into place. The cover will not close if the belt is in the wrong position.

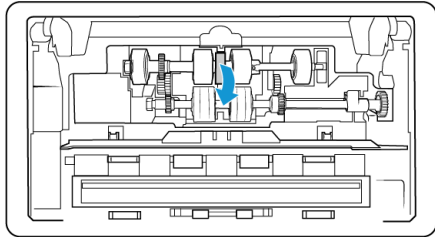

- Lift the roller cover and carefully push it closed to lock it in place. Make sure everything is aligned properly and the cover is fully closed. If the cover is not fully closed it will break during scanning and damage the scanner.

Scanner Part number 85-0325-### and higher

Scanner Part number 85-0339-### and higher

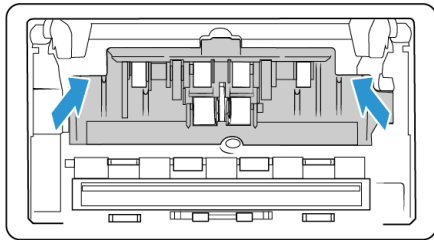
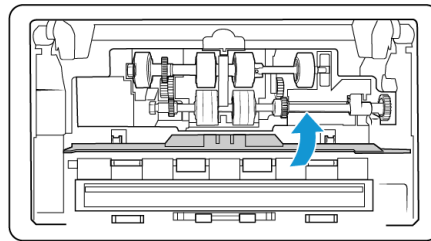
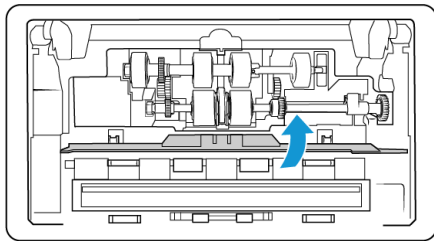

- Make sure the paper guides are properly seated in the scanner.

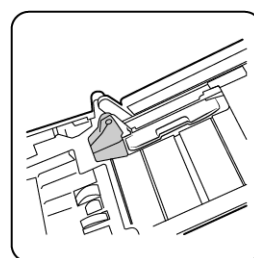
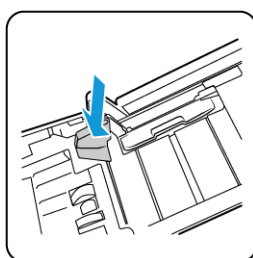
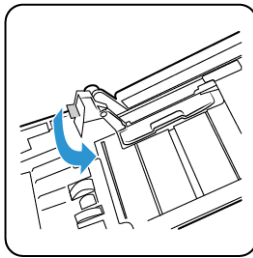

- Close the scanner when you're finished.

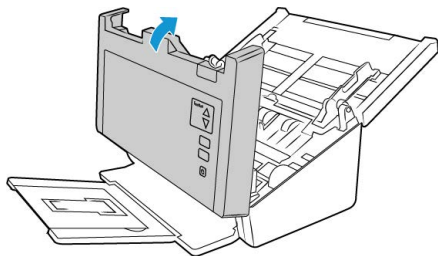

Troubleshooting

Problem: The scanner won't scan. What's wrong?

Check for one of these possible causes:

- **Are the cables loose or not plugged in securely?** Inspect the cable connections. Make sure the cables are plugged in securely.
- **Is the scanner's status light on?** Turn on the scanner's power. If the status light doesn't come on, plug the power supply into another electrical outlet. If you are using a UPS battery back-up or power strip, try plugging the scanner directly to a wall outlet.
- **Did you restart the computer and scanner?** If the scanner gets a paper jam, or loses connection because of an error, try restarting your computer and power cycling the scanner.
- **Did you plug the scanner into a USB hub?** If you're using a USB hub to connect the scanner try plugging the scanner's USB cable directly to the back of the computer. It is not recommended that you use the scanner with a USB hub, if you are using a hub, the hub must have its own power supply.
- **Is the USB cable 6' or less?** If you are using a USB cable that is longer than 6' you may lose connection to the scanner. The recommended USB cable length is 6' or less, the USB cable provided with your scanner is within this range.
- **Did you select another image source in the scanning software?** If you use multiple imaging devices with your computer, such as a camera, all-in-one printer, or another scanner, you may have selected another source for images. Make sure Xerox® D50 Scanner is selected as the scanner.

Problem: Why does my scanner not function after performing a system restore on Windows?

The system restore process may have corrupted some of the driver components. It is recommended that you reinstall your scanner driver. Please refer to "[Uninstalling Your Scanner](#)" for installation instructions.

Problem: Why won't my scanner buttons work after scanning with Windows Image Acquisition (WIA)?

After performing a scan using the WIA interface you must close the application you were using before scanning with the buttons on the scanner. This does not occur when scanning using the TWAIN or ISIS interface.

Problem: Why won't my scanner work after the computer has been sitting idle for several hours?

To resolve the problem, simply turn off the scanner power then turn it back on again.

This may occur after Windows goes into power saving mode to "hibernate" the computer into a low power state. When you move your mouse or type on the keyboard it "wakes" the computer back up and restores full power to the system. This power fluctuation during the computer's hibernating period may sometimes cause the scanner to lose communication to the computer.

Problem: The installation will not complete successfully. If installation finishes, the scanner's OneTouch options do not seem to work properly.

A likely cause is that some driver programs are already installed on your computer for another scanner. Or you previously had another Visioneer® or Xerox® scanner and that driver program is still on your computer. They are interfering with the installation and OneTouch options, and you need to remove those other drivers and re-install your Xerox® scanner. Please see the documentation that you received with the other scanner for the steps to remove its driver programs.

Problem: My computer keeps giving me out of hard drive space error messages.

The minimum requirement of free hard drive space is for the installation of the scanner driver and basic, low resolution, scanning. High resolution scans result in files that can be over 1 gigabyte in size. Free up some space on your hard drive for the software to be able to save the scanned images.

Problem: My computer keeps giving me out of memory error messages.

An "Out of memory" message may appear when scanning long pages at higher resolutions. This error is most often seen on older versions of Mac OS X, due to the large file size created when scanning long pages in color or grayscale at 300 dpi or higher. If you see an out of memory error message, please try adjusting the page length and/or scan resolution.

Problem: Images are corrupted when scanning and saving as a GIF file format.

This is a known issue when using older versions of OS X, at this time the issue has been seen on 10.6 and 10.7 but you may see this problem on other versions of OS X as well. Please use a different file format when scanning if you are seeing corrupted image.

Problem: The paper jams the ADF.

To reduce the number of paper jams, smooth and straighten the paper before scanning, and adjust the guides to the paper size. Paper fed into the ADF at an angle can cause the feed mechanism to jam. If paper jams are occurring more frequently, try cleaning the roller with a soft cloth dampened with Isopropyl rubbing alcohol. Excessive dust on the roller can make it appear worn and will cause issues feeding paper. See "[Cleaning Inside the Automatic Document Feeder](#)" for cleaning instructions.

Problem: The ADF won't feed pages properly.

A dirty or worn ADF pad assembly or dirt on the roller can cause documents to feed in skewed at an angle, or multiple pages to feed at the same time. Try cleaning the roller first. See "[Cleaning Inside the Automatic Document Feeder](#)". If that doesn't solve the problem, the pad assembly may need to be replaced. It is user replaceable. Please see "[Replacing the Reverse \(Separation\) Roller](#)" and "[Replacing the ADF \(Feed\) Roller](#)".

Problem: If the USB cable is disconnected during a scan, the scanner does not reconnect when the USB cable is plugged back in.

Unplug the power cable from the scanner, and then plug it back in.

If the scanner does not reconnect:

1. Unplug the power cable from the scanner.
2. Restart your computer.
3. After the restart is complete, plug the power cable back in.

Problem: The scanner reports a Double Feed error when there is only one page in the scanner.

Try cleaning the double feed detection sensor. Dust on the sensor may prevent the sensor from working properly.

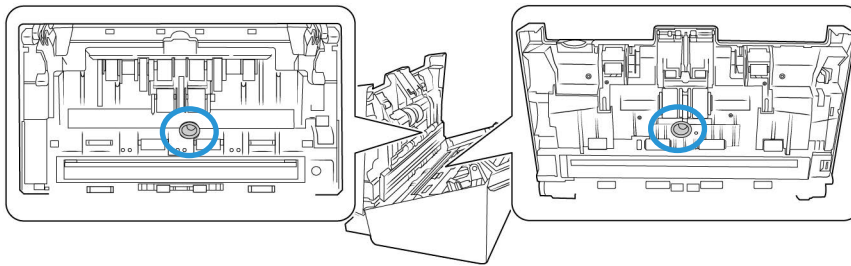

ERROR LIGHT TROUBLESHOOTING CODES

Normal Operation

- **Steady blue:** indicates the scanner is ready to scan.
- **Slow flashing blue:** indicates the scanner is in low power mode.
- **Rapid flashing blue:** indicates the scanner is waking up from low power mode.
- **Steady red:** the scanner is busy.
- **Flashing red:** the scanner is reporting an error.

Error Codes

The status light indicates the current state of the scanner. If your scanner experiences hardware problems, the status light turns red and will flash a specific number of times, pause, and then repeat the same number of flashes. The number of flashes between pauses indicates the hardware error code. The LED display will also flash an “E” then the error code number that matches the status light’s blinking pattern.

Descriptions of the most common patterns are listed below. In all cases, you should turn off the scanner and check the scanner setup. Make sure the USB cable is plugged into the scanner and computer. Make sure the power cord is plugged into the scanner and into a wall outlet. Contact Xerox Technical Support if you experience a different blinking pattern.

Error Code	Problem Description	Solution
0	Scanner is not connected to the computer (The LED does not flash "E" and the status light remains blue.)	A cable may be loose. Check that the scanner's cables are correctly attached to the computer. If the scanner still does not connect, re-boot the computer.
4	Paper jam	Open the ADF cover and remove the jammed page. See "Clearing Paper Jams" .
5	Multiple paper feed	Multiple pages have fed through the scanner at one time. Open the ADF door and remove the pages from the scanner. Make sure the pages are not stuck or taped together before loading them in the ADF. If the problem persists, clean the scanner as described in "Cleaning Inside the Automatic Document Feeder" .
6	The scanner's cover is open	The ADF door is not closed all the way. Open the scanner, make sure the paper guides are properly seated in the scanner and that the roller covers are fully closed, and then close the ADF again. Push down on the lid until it locks into place.
7, 8	The lamp in the scanner body or lid has malfunctioned	This usually occurs if the power was disconnected during a scan. Turn the scanner off, then back on again. If the problem persists, turn off the scanner, re-start the computer, then turn the scanner on. If the problem continues, and your scanner's power is plugged into a surge protector or UPS battery backup, try plugging the scanner power directly into a wall outlet.
All Other Codes	An internal part in the scanner may have malfunctioned	Turn off the power to your scanner, re-boot your computer, then turn it back on. If the problem persists, contact Xerox Technical Support.

Uninstalling Your Scanner

Please leave the scanner's USB cable plugged into the computer while uninstalling the scanner driver. Unplug the USB cable when directed to do so in the instructions below.

WINDOWS

Use the options in the Windows Control Panel to remove the scanner driver and modules, and any other software provided with the scanner.

Open the list of installed programs in the Windows Control panel.

- Windows 7 and later: Open Programs and Features

Uninstalling the scanner driver:

1. In the list of installed programs click on **Xerox® D50 Scanner driver**.

2. Click the **Change/Remove** or **Uninstall** button.
3. Click **Yes** when asked to confirm that you want to remove the driver.

When the driver uninstallation is complete the progress window will automatically close.

4. Turn off the scanner and unplug the USB cable.
5. Reboot the computer if you are prompted to do so.

Follow these instructions to remove any of the other software you installed with your scanner. Depending on the software provided with your scanner, and which applications you installed during the scanner setup, the application list may include:

- Visioneer OneTouch
- Visioneer OneTouch OCR module

Uninstalling Visioneer Acuity™:

Visioneer Acuity is automatically installed when you install the scanner driver using the installation disc. You can also download the Visioneer Acuity module from the support pages for your scanner at www.xeroxscanners.com. Visioneer Acuity is a utility with advanced image processing options to instantly improve the visual clarity of anything you scan.

1. In the list of installed programs select **Visioneer Acuity Assets**.
2. Click **Yes** when asked to confirm you want to remove the software.

Depending on the method of installation, and your scanner model, there may be multiple entries for Visioneer Acuity in the installed programs list. The additional entries in this list are the image processing libraries needed to support various scanner models. These additional items will be called "Visioneer Acuity Assets" followed by a version number. In the scenario described here, when you want to uninstall Visioneer Acuity make sure you select and uninstall Visioneer Acuity. If you uninstall one of the entries labeled as an "asset" you will still need to uninstall the main Visioneer Acuity utility.

MAC

Uninstalling the scanner driver:

The TWAIN driver is stored in the TWAIN Data Sources folder, and DS is its file extension.

1. Disconnect the USB cable of your device.
2. In the Finder, browse to **Macintosh HD > Library > Image Capture > TWAIN Data Sources**.
3. Delete the DS file for your device.

Uninstalling Visioneer Scan Utility:

The Visioneer Scan Utility is in the macOS Applications folder.

1. In the Finder, browse to **Macintosh HD > Applications**
2. Delete the Visioneer Scan Utility.

The Image Capture Application (ICA) from Apple is used to transfer images from your scanner, and it is also in the macOS Applications folder. If no longer needed, then you can optionally delete it.

After deleting your files, empty the Trash contents, and restart your system.



Xerox® D50 Scanner Specifications

Scanner Specifications	
Document Requirements	
Minimum Item Size	2 x 2 inches (51 x 51 mm)
Maximum Item Size	8.5 x 118 inches (216 x 2997 mm) up to 300 dpi 8.5 x 59 inches (216 x 1499 mm) at 400 dpi and higher
Capacity	80 pages of 20lb printer paper (75–80 g/m ²)
Paper Thickness	7–110 lbs. (27–413 g/m ²)
Plastic Card	Embossed cards up to 1.25 mm thick
General Specifications	
Scanning Speeds	<ul style="list-style-type: none"> 60 pages per minute / 120 images per minute @ 200 dpi 40 pages per minute / 80 images per minute @ 300 dpi
• A4 Page Size	
Optical Resolutions	200, 300, and 600 dpi
Interpolated Resolutions	75, 100, 150, 400, 500, and 1200 dpi (these resolutions are available when Visioneer Acuity is installed)
Internal Bit Depth	48-bit color, 16-bit grayscale, 1-bit bitonal (black & white)
Output Bit Depth	24-bit color, 8-bit grayscale, 1-bit bitonal (black & white)
Scan Method	Duplex Automatic Document Feeder (ADF)
Image Sensor	CCD (Charge-Coupled Device)
Light Source	White LED lamp
Interface	Hi-Speed USB 3.0, compatible with USB 1.1
Certifications	FCC Class B, WEEE, RoHS, ENERGY STAR, UL/C-UL, CB, CU(EAC), RCM, CCC, KCC, USB-IF, Mexico Energy (CFE)
Operating Temperature	40° ~ 95° F (5° ~ 35° C without condensation)
Relative Humidity	10% ~ 90% (@35° C without condensation)
Scanner Dimensions	
Width	12.5 inches (316 mm)
Depth	7.5 inches (191 mm)
Height	6.6 inches (168 mm)
Weight	9.2 pounds (4.2 kg)
Scanner Dimensions (Trays Extended)	
Width	12.5 inches (316 mm)
Depth	26.8 inches (680 mm)
Height	9.5 inches (239 mm)
Weight	9.2 pounds (4.2 kg)

Scanner Specifications	
Power Information	
Power Supply	APD (DA-48M24) DC Jack, 3P, 100~240Vac, 24Vdc, 2A, 48W, Class 1, ENERGY STAR, RoHS
Scanner Rating	24Vdc, 2.0A
Power consumption	Scanner Part number 85-0325-###: ≤ 24 Watts (during operation) Scanner Part number 85-0339-###: ≤ 36 Watts (during operation) ≤ 8 Watts (ready) ≤ 2.5 Watts (power save after 15 minutes without scanning) ≤ 0.5 Watt (power off)
Cable Information	
AC Power Cord	US,3P,7A/125V, L=1800mm, 3C*18AWG, BLACK, LONGWELL (PH8B1EDJF0AA05B), RoHS EUR.(CEE),2P+G. BASE,16A/250V,L=1800mm,3Cx0.75mm ² ,BLACK, LONGWELL (PG8B9CIJG0A-05B),RoHS UK(BS/PSB),3P,3A/250V,L=1800mm,3C*0.75mm ² ,BLACK, LONGWELL (PG8B9X3JG0A-05B), RoHS
USB cable	1850 mm, 28AWG, with core, RoHS compliant
Software Information	
Supported Operating Systems	<ul style="list-style-type: none"> Microsoft: <ul style="list-style-type: none"> – 32-bit or 64-bit 7 (Service Pack 1) – 32-bit or 64-bit 10 – 32-bit or 64-bit 11 Mac: <ul style="list-style-type: none"> – Apple® Mac OS X® (11–14)
Scanner Drivers	<ul style="list-style-type: none"> Microsoft: <ul style="list-style-type: none"> – TWAIN, WIA, ISIS Mac: <ul style="list-style-type: none"> – TWAIN, ICA
Bundled Software	<ul style="list-style-type: none"> Microsoft: <ul style="list-style-type: none"> – Visioneer® OneTouch – Visioneer® Acuity Module Mac: <ul style="list-style-type: none"> – Visioneer® Scan Utility

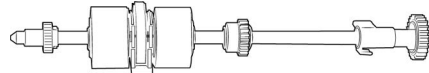
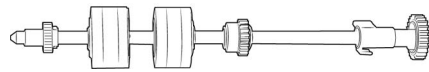
Xerox® D50 Scanner Parts List

Part Name	Part Number	
ADF Roller	Scanner Part number 85-0325-### and higher: <ul style="list-style-type: none"> • 65-2457-000 	
	Scanner Part number 85-0339-### and higher: <ul style="list-style-type: none"> • 65-2609-000 	

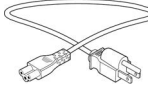
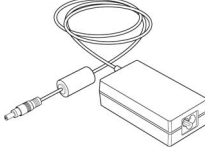
Part Name	Part Number	
Reverse (Separation) Roller	Scanner Part number 85-0325-### and higher: • 65-2459-000	
	Scanner Part number 85-0339-### and higher: • 65-2611-000	
USB Cable	35-0118-000	
AC Power Cord	35-0103-000 (US) 35-0104-000 (EUR) 35-0105-000 (UK)	
Power Supply	37-0098-000	

7. Appendix A: Regulatory Information

Basic Regulations

UNITED STATES (FCC REGULATIONS)



This equipment has been tested and found to comply with the limits for a Class B digital device, pursuant to Part 15 of the FCC Rules. These limits are designed to provide reasonable protection against harmful interference in a residential installation. This equipment generates, uses, and can radiate radio frequency energy and, if not installed and used in accordance with the instruction manual, may cause harmful interference to radio communications.

Operation of this equipment in a residential area is likely to cause harmful interference in which case the user will be required to correct the interference at his own expense.

⚠ WARNING! In order to allow this equipment to operate in close proximity to Industrial, Scientific and Medical (ISM) equipment, the external radiation from ISM equipment may have to be limited or special mitigation measures taken.

Changes and modifications to this equipment not specifically approved by Xerox® may void the user's authority to operate this equipment.

Shielded cables must be used with this equipment to maintain compliance with FCC regulations.

GREAT BRITAIN



The UKCA mark applied to this product, symbolizes our declaration of conformity with the following applicable Great Britain Regulations, as of the dates indicated:

December 8, 2016:	Electrical Equipment (Safety) Regulations 2016
December 8, 2016:	Electromagnetic Compatibility Regulations 2016

A full declaration of conformity, defining the relevant directives and referenced standards, can be obtained from your Xerox Limited representative or by contacting:

Environment, Health and Safety
Xerox (UK)
Sanderson Road
Uxbridge UB8 1DH

EUROPEAN UNION

The CE mark applied to this product, symbolizes our declaration of conformity with the following applicable European Union Directives, as of the dates indicated:



September 8, 2017:	Council Directive 2014/35/EU as amended. Approximation of the laws of the member states related to low voltage equipment.
August 12, 2016:	Council Directive 2014/30/EU as amended. Approximation of the laws of the member states related to electromagnetic compatibility.

This machine is certified as Class 1 LED product. This means that this machine does not produce hazardous laser radiation.

A full declaration of conformity, defining the relevant directives and referenced standards, can be obtained from your Xerox Limited representative or by contacting:

Environment, Health and Safety
 Xerox (NL)
 Sint Jansweg 15
 NL-5928 RC
 VENLO
 Téléphone 1-800-ASK-XEROX

TURKEY (ROHS REGULATION)

In compliance with Article 7 (d) We hereby certify “It is in compliance with the EEE Regulation”.

(“EEE yönetmeliğine uygundur“)

Copy Regulations**UNITED STATES**

Congress, by statute, has forbidden the reproduction of the following subjects under certain circumstances. Penalties of fine or imprisonment may be imposed on those guilty of making such reproductions.

1. Obligations or Securities of the United States Government, such as:

Certificates of Indebtedness	National Bank Currency	Coupons from Bonds
Federal Reserve Bank Notes	Silver Certificates	Gold Certificates
United States Bonds	Treasury Notes	Federal Reserve Notes
Fractional Notes	Certificates of Deposit	Paper Money

Bonds and Obligations of certain agencies of the government, such as FHA, etc.

Bonds. (U.S. Savings Bonds may be photographed only for publicity purposes in connection with the campaign for the sale of such bonds.)

Internal Revenue Stamps. (If it is necessary to reproduce a legal document on which there is a canceled revenue stamp, this may be done provided the reproduction of the document is performed for lawful purposes.)

Postage Stamps, canceled or uncanceled. (For philatelic purposes, Postage Stamps may be photographed, provided the reproduction is in black and white and is less than 75 % or more than 150 % of the linear dimensions of the original.)

Postal Money Orders.

Bills, Checks, or Drafts of money drawn by or upon authorized officers of the United States.

Stamps and other representatives of value, of whatever denomination, which have been or may be issued under any Act of Congress.

2. Adjusted Compensation Certificates for Veterans of the World Wars.
3. Obligations or Securities of any Foreign Government, Bank, or Corporation.
4. Copyrighted material, unless permission of the copyright owner has been obtained or the reproduction falls within the "fair use" or library reproduction rights provisions of the copyright law. Further information of these provisions may be obtained from the Copyright Office, Library of Congress, Washington, D.C. 20559. Ask for Circular R21.
5. Certificates of Citizenship or Naturalization. (Foreign Naturalization Certificates may be photographed.)
6. Passports. (Foreign Passports may be photographed.)
7. Immigration Papers.
8. Draft Registration Cards.
9. Selective Service Induction Papers that bear any of the following Registrant's information:

Earnings or Income	Dependency Status	Court Record
Previous military service	Physical or mental condition	

Exception: U. S. Army and Navy discharge certificates may be photographed.

10. Badges, Identification Cards, Passes, or Insignia carried by military personnel, or by members of the various Federal Departments, such as FBI, Treasury, etc. (unless photograph is ordered by the head of such department or bureau.)
11. Reproducing the following is also prohibited in certain states: Automobile Licenses — Drivers' Licenses — Automobile Certificates of Title.

The above list is not all inclusive, and no liability is assumed for its completeness or accuracy. In case of doubt, consult your attorney.

CANADA

Parliament, by statute, has forbidden the reproduction of the following subjects under certain circumstances. Penalties of fines or imprisonment may be imposed on those guilty of making such copies.

1. Current bank notes or current paper money.

2. Obligations or securities of a government or bank.
3. Exchequer bill paper or revenue paper.
4. The public seal of Canada or of a province, or the seal of a public body or authority in Canada, or of a court of law.
5. Proclamations, orders, regulations or appointments, or notices thereof (with intent to falsely cause same to purport to have been printed by the Queen's Printer for Canada, or the equivalent printer for a province).
6. Marks, brands, seals, wrappers or designs used by or on behalf of the Government of Canada or of a province, the government of a state other than Canada or a department, board, Commission or agency established by the Government of Canada or of a province or of a government of a state other than Canada.
7. Impressed or adhesive stamps used for the purpose of revenue by the Government of Canada or of a province or by the government of a state other than Canada.
8. Documents, registers or records kept by public officials charged with the duty of making or issuing certified copies thereof, where the reproduction falsely purports to be a certified copy thereof.
9. Copyrighted material or trademarks of any manner or kind without the consent of the copyright or trademark owner.

The above list is provided for your convenience and assistance, but it is not all inclusive, and no liability is assumed for its completeness or accuracy. In case of doubt, consult your solicitor.

OTHER COUNTRIES

Copying certain documents may be illegal in your country. Penalties of fine or imprisonment may be imposed on those found guilty of making such reproductions.

- Currency notes
- Bank notes and cheques
- Bank and government bonds and securities
- Passports and identification cards
- Copyright material or trademarks without the consent of the owner
- Postage stamps and other negotiable instruments

Note: this list is not inclusive and no liability is assumed for either its completeness or accuracy. In case of doubt, contact your legal counsel.

8. Appendix B: Compliance Information

Product Recycling & Disposal

USA & CANADA

If you are managing the disposal of your Xerox® product, please note that the product may contain lead, mercury, Perchlorate, and other materials whose disposal may be regulated due to environmental considerations. The presence of these materials is fully consistent with global regulations applicable at the time that the product was placed on the market. For recycling and disposal information, contact your local authorities.

Perchlorate Material - This product may contain one or more Perchlorate-containing devices, such as batteries. Special handling may apply.

EUROPEAN UNION

RoHS and WEEE Compliance

This product is compliant with RoHS Regulations of the European Parliament and Council Directive on the Restrictions of the Use of Certain Hazardous Substances in Electrical and Electronic Equipment (2011/65/EU), and with the Waste Electrical and Electronic Equipment (WEEE) Directive (2012/19/EU).

Some equipment may be used in both a domestic/household and a professional/business application.

Professional/Business Environment

Application of this symbol on your equipment is confirmation that you must dispose of this equipment in compliance with agreed national procedures. In accordance with European legislation, end of life electrical and electronic equipment subject to disposal must be managed within agreed procedures.



ENERGY STAR for the USA

Energy Program Compliance

The Xerox® D50 Scanner is ENERGY STAR qualified under the ENERGY STAR Program Requirements for Imaging Equipment.



The ENERGY STAR and ENERGY STAR MARK are registered United States trademarks. The ENERGY STAR Imaging Equipment Program is a team effort between U.S., European Union and Japanese governments and the office equipment industry to promote energy-efficient copiers, printers, fax, multifunction machine, personal computers, and monitors. Reducing product energy consumption helps combat smog, acid rain and long-term changes to the climate by decreasing the emissions that result from generating electricity.

Xerox® D50 Scanner is preset at the factory. Your machine will be delivered with the timer for switching to Power Save Mode from the last scan set at 15 minutes.